

EIKI

MULTIMEDIA PROJECTOR

MODEL LC-SD12

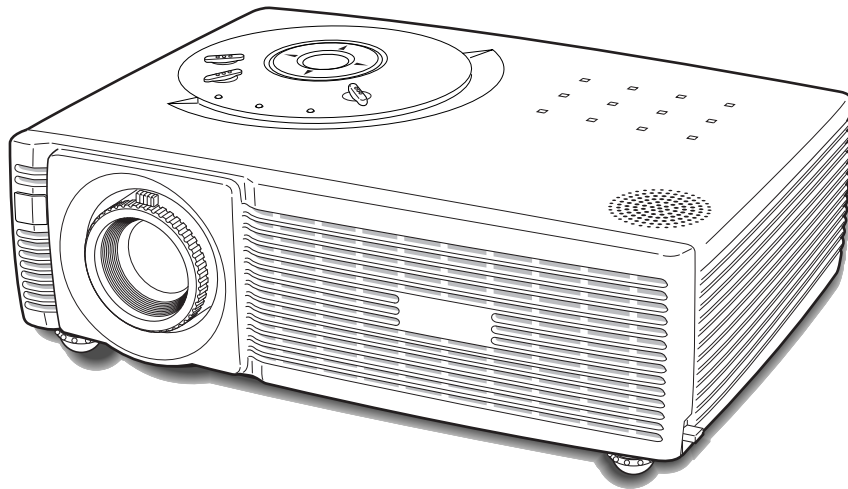

OWNER'S MANUAL

Features and Design

This Multimedia Projector is designed with the most advanced technology for portability, durability, and ease of use. This projector utilizes built-in multimedia features, a palette of 16.77 million colors, and matrix liquid crystal display (LCD) technology.

Greater Mobility

Extremely compact in size and weight. It is designed to be carried and work anywhere you wish to use.

Outstanding Compatibility

This projector widely accepts various video and computer input signals including;

- **Computers**
IBM-compatible or Macintosh computer up to 1280 x 1024 resolution.
- **6 Color Systems**
NTSC, PAL, SECAM, NTSC 4.43, PAL-M or PAL-N color system can be connected.
- **Component Video**
Component video signal, such as a DVD player output, high definition TV signals including 480i, 480p, 575i, 575p, 720p, 1035i or 1080i, can be connected.
- **S-Video**
S-Video signal, such as a S-VHS VCR output signal, can be connected.
- **RGB Scart**
RGB Scart signal can be connected.

Superb Image Quality

Supports 800 x 600 dots resolution for computer input. Resolution from a computer between SVGA (800 x 600) and SXGA (1280 x 1024) is precisely compressed into 800 x 600 dots.

Multi-Scan System

This projector has Multi-Scan System to conform to almost all computer output signals quickly. No need for troublesome manual adjustment of frequency and other settings. (P23)

Auto PC Adjustment

Incoming computer signals are recognized and the best adjustment is automatically set by Auto PC Adjustment. No complicated setup is necessary and projection is always precise. (P24)

Digital Zoom (for Computer)

Digital zoom function expands (to approx. 16 times of screen size) or compresses the image size, allowing you to focus on crucial information at a presentation. (P29)

Digital Keystone Adjustment

Positioning height of the projector may result in distorted image being displayed in a trapezoid shape. Keystone adjustment solves this problem by digitally altering projection to produce undistorted images. (P20, P36)

Interlace Progressive Conversion

High-quality picture is available with this technology which converts interlace signal into progressive signal. (P35)

Multi-language Menu Display

Operation menu is displayed in; English, German, French, Italian, Spanish, Portuguese, Dutch, Swedish, Russian, Chinese, Korean or Japanese. (P36)

User Logo

A projected image can be captured and used for the starting display of the projector. (" Capture function" P36)
You can also display the captured image in an interval during your presentation instead of blackout image. (" No Show function" P21)

Power Management

Provided to reduce power consumption and maintain the lamp life. (P37)

Key Lock Function

Provided to lock the operation of the projector. This function protects the projector from being tampered with by third persons. (P38)

Table of Contents

Features and Design	2	Computer Input	22
Table of Contents	3	Input Source Selection	22
To the Owner	4	Computer System Selection	23
Safety Instructions	5	Auto PC Adjustment	24
Air Circulation	6	Manual PC Adjustment	25
Installing the Projector in Proper Position	6	Image Level Selection	27
Moving the Projector	6	Image Level Adjustment	28
Compliance	7	Screen Size Adjustment	29
Parts Names and Functions	8	Video Input	30
Front	8	Input Source Selection (Video, S-Video)	30
Back	8	Input Source Selection (Component, RGB Scart 21-pin)	31
Bottom	8	Video System Selection	32
Terminals	9	Image Level Selection	33
Top panel	10	Image Level Adjustment	34
Remote Control	11	Screen Size Adjustment	35
Operating Range	11	Setting	36
Remote Control Battery Installation	12	Setting Menu	36
Installation	13	Maintenance and Cleaning	39
Positioning the Projector	13	Warning Indicator	39
Adjustable Feet	13	Air Filter	40
Connecting the AC Power Cord	14	Attaching the Lens Cover	40
Connecting to a Computer	15	Cleaning the Projection Lens	41
Connecting to Video Equipment	16	Cleaning the Projector Cabinet	41
Basic Operation	17	Lamp Replacement	42
Turning On the Projector	17	Lamp Replace Counter	43
Turning Off the Projector	17	Appendix	44
How to Operate the On-Screen Menu	18	Troubleshooting	44
Menu Bar	19	Indicators and Projector Condition	46
Zoom Adjustment	20	Menu Tree	47
Focus Adjustment	20	Compatible Computer Specifications	49
Keystone Adjustment	20	Technical Specifications	50
Picture Freeze Function	20	Configuration of Terminals	51
No Show Function	21	Optional Parts	51
P-Timer Function	21		
Sound Adjustment	21		

TRADEMARKS

- Apple, Macintosh, and PowerBook are trademarks or registered trademarks of Apple Computer, Inc.
- IBM, VGA, XGA, and PS/2 are trademarks or registered trademarks of International Business Machines, Inc.
- Windows and PowerPoint are registered trademarks of Microsoft Corporation.
- Each name of corporations or products in the owner's manual is a trademark or a registered trademark of its respective corporation.





To the Owner

Before operating this projector, read this manual thoroughly to operate the projector properly.

This projector provides many convenient features and functions. Operating the projector properly enables you to manage those features and maintains it in better condition for a considerable time.

Improper operation may result in not only shortening the product-life, but also malfunctions, a fire hazard, or other accidents.

If your projector seems to operate improperly, read this manual again, check operations and cable connections and try the solutions in the "Troubleshooting" section at the end of this booklet. If the problem still persists, contact the sales dealer where you purchased the projector or the service center.

	CAUTION RISK OF ELECTRIC SHOCK DO NOT OPEN	
CAUTION : TO REDUCE THE RISK OF ELECTRIC SHOCK, DO NOT REMOVE COVER (OR BACK). NO USER-SERVICEABLE PARTS INSIDE EXCEPT LAMP REPLACEMENT. REFER SERVICING TO QUALIFIED SERVICE PERSONNEL.		
	THIS SYMBOL INDICATES THAT DANGEROUS VOLTAGE CONSTITUTING A RISK OF ELECTRIC SHOCK IS PRESENT WITHIN THIS UNIT.	
	THIS SYMBOL INDICATES THAT THERE ARE IMPORTANT OPERATING AND MAINTENANCE INSTRUCTIONS IN THE OWNER'S MANUAL WITH THIS UNIT.	



Safety Precaution

WARNING : TO REDUCE THE RISK OF FIRE OR ELECTRIC SHOCK, DO NOT EXPOSE THIS APPLIANCE TO RAIN OR MOISTURE.

- This projector produces intense light from the projection lens. Do not stare directly into the lens as possible. Eye damage could result. Be especially careful that children do not stare directly into the beam.
- Install the projector in a proper position. If not, it may result in a fire hazard.
- Take appropriate space on the top, sides and rear of the projector cabinet for allowing air circulation and cooling the projector. Minimum distance should be taken. If the projector is to be built into a compartment or similarly enclosed, the minimum distances must be maintained. Do not cover the ventilation slot on the projector. Heat build-up can reduce the service life of your projector, and can also be dangerous.

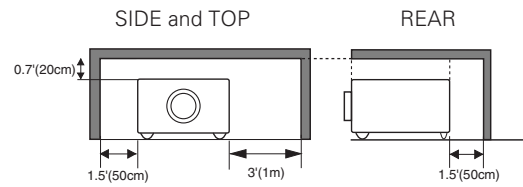

- Do not put any flammable object or spray can near the projector, hot air is exhausted from the ventilation holes.
- If the projector is not to be used for an extended time, unplug the projector from the power outlet.

READ AND KEEP THIS OWNER'S MANUAL FOR LATER USE.

CAUTION

Not for use in a computer room as defined in the Standard for the Protection of Electronic Computer/Data Processing Equipment, ANSI/NFPA 75.

Ne peut être utilisé dans une salle d'ordinateurs telle que définie dans la norme ANSI/NFPA 75 Standard for Protection of Electronic Computer/Data Processing Equipment

Safety Instructions

All the safety and operating instructions should be read before the product is operated.

Read all of the instructions given here and retain them for later use. Unplug this projector from AC power supply before cleaning. Do not use liquid or aerosol cleaners. Use a damp cloth for cleaning.

Follow all warnings and instructions marked on the projector.

For added protection to the projector during a lightning storm, or when it is left unattended and unused for long periods of time, unplug it from the wall outlet. This will prevent damage due to lightning and power line surges.

Do not expose this unit to rain or use near water, for example, in a wet basement, near a swimming pool, etc..

Do not use attachments not recommended by the manufacturer as they may cause hazards.

Do not place this projector on an unstable cart, stand, or table. The projector may fall, causing serious injury to a child or adult, and serious damage to the projector. Use only with a cart or stand recommended by the manufacturer, or sold with the projector. Wall or shelf mounting should follow the manufacturer's instructions, and should use a mounting kit approved by the manufacturers.

An appliance and cart combination should be moved with care. Quick stops, excessive force, and uneven surfaces may cause the appliance and cart combination to overturn.



Slots and openings in the back and bottom of the cabinet are provided for ventilation, to insure reliable operation of the equipment and to protect it from overheating.

The openings should never be covered with cloth or other materials, and the bottom opening should not be blocked by placing the projector on a bed, sofa, rug, or other similar surface. This projector should never be placed near or over a radiator or heat register.

This projector should not be placed in a built-in installation such as a book case unless proper ventilation is provided.

Never push objects of any kind into this projector through cabinet slots as they may touch dangerous voltage points or short out parts that could result in a fire or electric shock. Never spill liquid of any kind on the projector.

Do not install the projector near the ventilation duct of air-conditioning equipment.

This projector should be operated only from the type of power source indicated on the marking label. If you are not sure of the type of power supplied, consult your authorized dealer or local power company.

Do not overload wall outlets and extension cords as this can result in fire or electric shock. Do not allow anything to rest on the power cord. Do not locate this projector where the cord may be damaged by persons walking on it.

Do not attempt to service this projector yourself as opening or removing covers may expose you to dangerous voltage or other hazards. Refer all servicing to qualified service personnel.

Unplug this projector from wall outlet and refer servicing to qualified service personnel under the following conditions:

- a. When the power cord or plug is damaged or frayed.
- b. If liquid has been spilled into the projector.
- c. If the projector has been exposed to rain or water.
- d. If the projector does not operate normally by following the operating instructions. Adjust only those controls that are covered by the operating instructions as improper adjustment of other controls may result in damage and will often require extensive work by a qualified technician to restore the projector to normal operation.
- e. If the projector has been dropped or the cabinet has been damaged.
- f. When the projector exhibits a distinct change in performance-this indicates a need for service.

When replacement parts are required, be sure the service technician has used replacement parts specified by the manufacturer that have the same characteristics as the original part. Unauthorized substitutions may result in fire, electric shock, or injury to persons.

Upon completion of any service or repairs to this projector, ask the service technician to perform routine safety checks to determine that the projector is in safe operating condition.

Voor de klanten in Nederland



Bij dit produkt zijn batterijen geleverd. Wanneer deze leeg zijn, moet u ze niet weggooien maar inleveren als KCA.

Air Circulation

Openings in the cabinet are provided for ventilation and to ensure reliable operation of the product and to protect it from overheating, and these openings must not be blocked or covered.

CAUTION

Hot air is exhausted from the exhaust vent. When using or installing the projector, the following precautions should be taken.

- Do not put any flammable objects near the vent.
- Keep the exhaust vent at least 3'(1m) away from any objects.
- Do not touch a peripheral part of the exhaust vent, especially screws and metallic part. This area will become hot while the projector is being used.
- Do not put anything on the cabinet. The materials put on the cabinet will not only get damaged but also cause fire hazard by heat.

Cooling fans are provided to cool down the projector. This projector monitors internal temperature and control the running speed of the cooling fans.

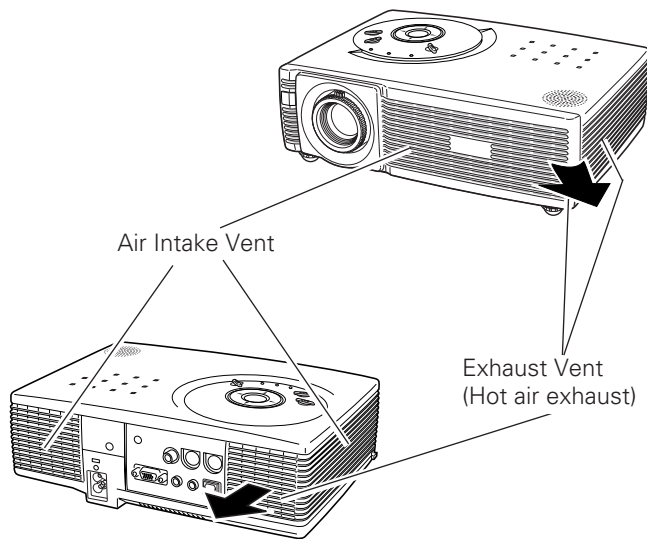

Installing the Projector in Proper Position

Install the projector properly. Improper Installation may reduce the lamp lifetime and cause a fire hazard.

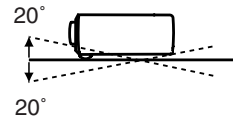

Do not tilt the projector more than 20 degrees above and below.



NO UPWARD

Do not point the projector up to project an image.



NO DOWNWARD

Do not point the projector down to project an image.



NO SIDEWARD

Do not put the projector on either side to project an image.

Moving the Projector

When moving the projector, replace the Lens Cover and retract Adjustable Feet to prevent damage to the lens and cabinet.

When the projector is not in use for an extended period, put it into the case (carrying bag) supplied with the projector.

CAUTION

Carrying Bag (supplied) is intended for protection from dust and scratches on the surface of a cabinet, and it is not designed to protect an appliance from external forces. Do not transport a projector through a courier or transport services with this bag, otherwise the projector can be damaged. When handling a projector, do not drop, bump, subject it to strong forces or put other things on the cabinet.

CAUTION IN CARRYING OR TRANSPORTING THE PROJECTOR

- Do not drop or bump a projector, otherwise damages or malfunctions may result.
- When carrying a projector, use a suitable carrying case.
- Do not transport a projector by using a courier or transport service in an unsuitable transport case. This may cause damage to a projector. To transport a projector through a courier or transport service, consult your dealer for best way.

Compliance

Federal Communication Commission Notice

Note : This equipment has been tested and found to comply with the limits for a Class B digital device, pursuant to part 15 of the FCC Rules. These limits are designed to provide reasonable protection against harmful interference in a residential installation. This equipment generates, uses and can radiate radio frequency energy and, if not installed and used in accordance with the instructions, may cause harmful interference to radio communications. However, there is no guarantee that interference will not occur in a particular installation. If this equipment does cause harmful interference to radio or television reception, which can be determined by turning the equipment off and on, the user is encouraged to try to correct the interference by one or more of the following measures :

- Reorient or relocate the receiving antenna.
- Increase the separation between the equipment and receiver.
- Connect the equipment into an outlet on a circuit different from that to which the receiver is connected.
- Consult the dealer or an experienced radio/TV technician for help.

Use of shielded cable is required to comply with class B limits in Subpart B of Part 15 of FCC Rules.

Do not make any changes or modifications to the equipment unless otherwise specified in the instructions. If such changes or modifications should be made, you could be required to stop operation of the equipment.

Model Number : LC-SD12
Trade Name : EIKI
Responsible party : EIKI International, Inc.
Address : 30251 Esperanza, Rancho Santa Margarita,
CA 92688-2132 U.S.A.
Telephone No. : 800-242-3454 (949-457-0200)

AC Power Cord Requirement

The AC Power Cord supplied with this projector meets the requirement for use in the country you purchased it.

AC Power Cord for the United States and Canada :

AC Power Cord used in the United States and Canada is listed by the Underwriters Laboratories (UL) and certified by the Canadian Standard Association (CSA).

AC Power Cord has a grounding-type AC line plug. This is a safety feature to be sure that the plug will fit into the power outlet. Do not try to defeat this safety feature. Should you be unable to insert the plug into the outlet, contact your electrician.

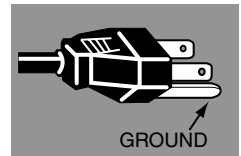

THE SOCKET-OUTLET SHOULD BE INSTALLED NEAR THE EQUIPMENT AND EASILY ACCESSIBLE.

Parts Names and Functions

Front

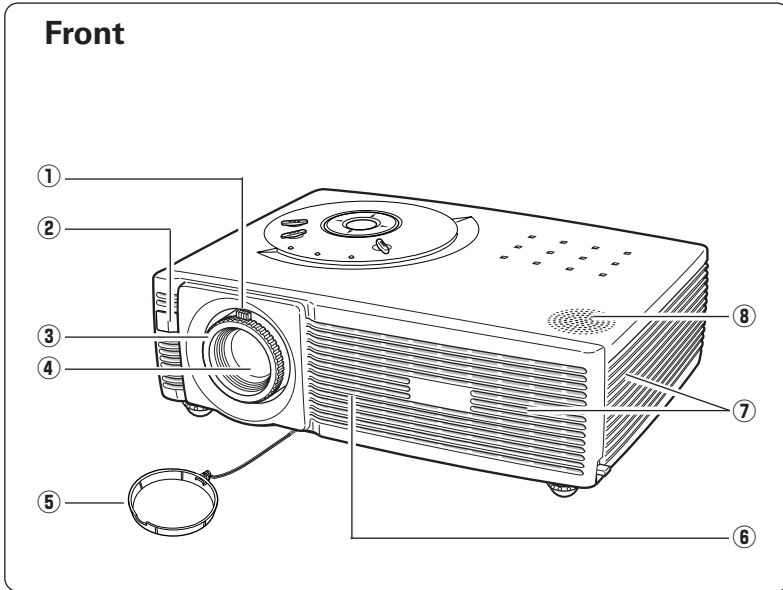

- ① **Zoom Lever** (P20)
- ② **Infrared Remote Receiver** (P11)
- ③ **Focus Ring** (P20)
- ④ **Projection Lens** (P41)
- ⑤ **Lens Cover** (P40)
- ⑥ **Air Intake Vent** (P40)
- ⑦ **Exhaust Vent**



Hot air is exhausted from the exhaust vent.
Do not put heat-sensitive objects near this side.

- ⑧ **Speaker**

Back

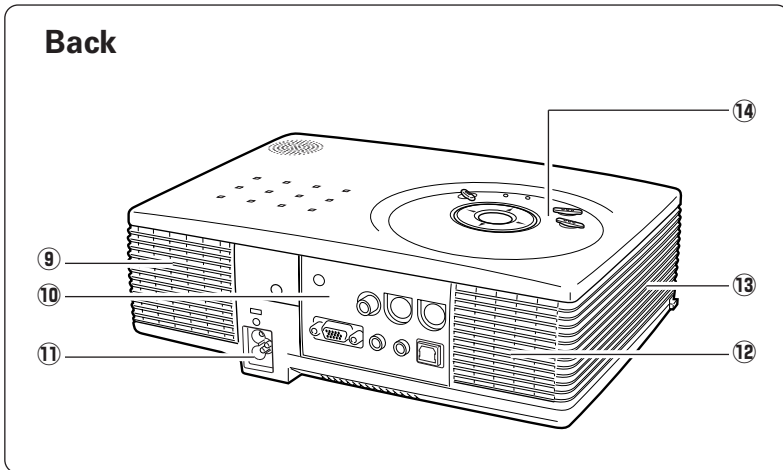

- ⑨ **Air Intake Vent** (P40)
- ⑩ **Terminals and Connectors** (P9, 15, 16)
- ⑪ **Power Cord Connector** (P14)
- ⑫ **Exhaust Vent**



Hot air is exhausted from the exhaust vent.
Do not put heat-sensitive objects near this side.

- ⑬ **Air Intake Vent** (P40)
- ⑭ **Top Controls and Indicators** (P10)

Bottom

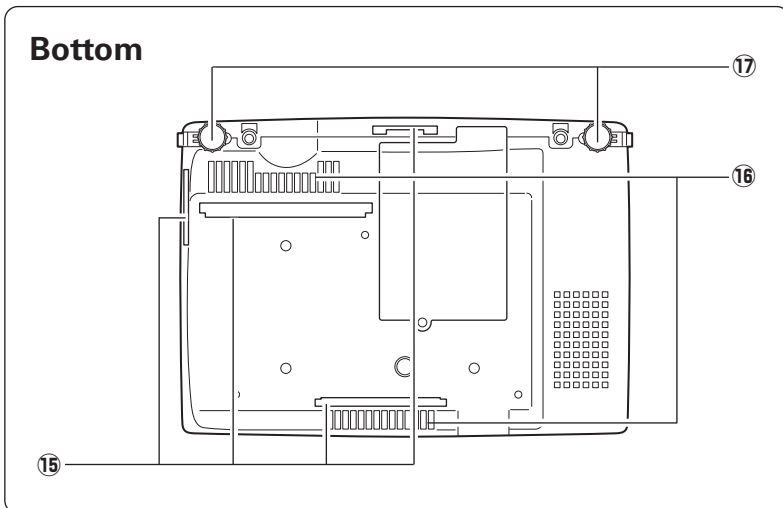

- ⑮ **Air Filters** (P40)
- ⑯ **Air Intake Vents** (P40)
- ⑰ **Adjustable Feet** (P13)



Hot air is exhausted from the exhaust vents.
When using or installing the projector, the following precautions should be taken.

- Do not put any flammable objects near these vents.
- Keep front grills at least 3'(1m) away from any objects, especially heat-sensitive objects.
- Do not touch this area, especially screws and metallic part. This area will become hot while the projector is being used.

This projector detects internal temperature and will automatically adjust the running speed of the cooling fans.

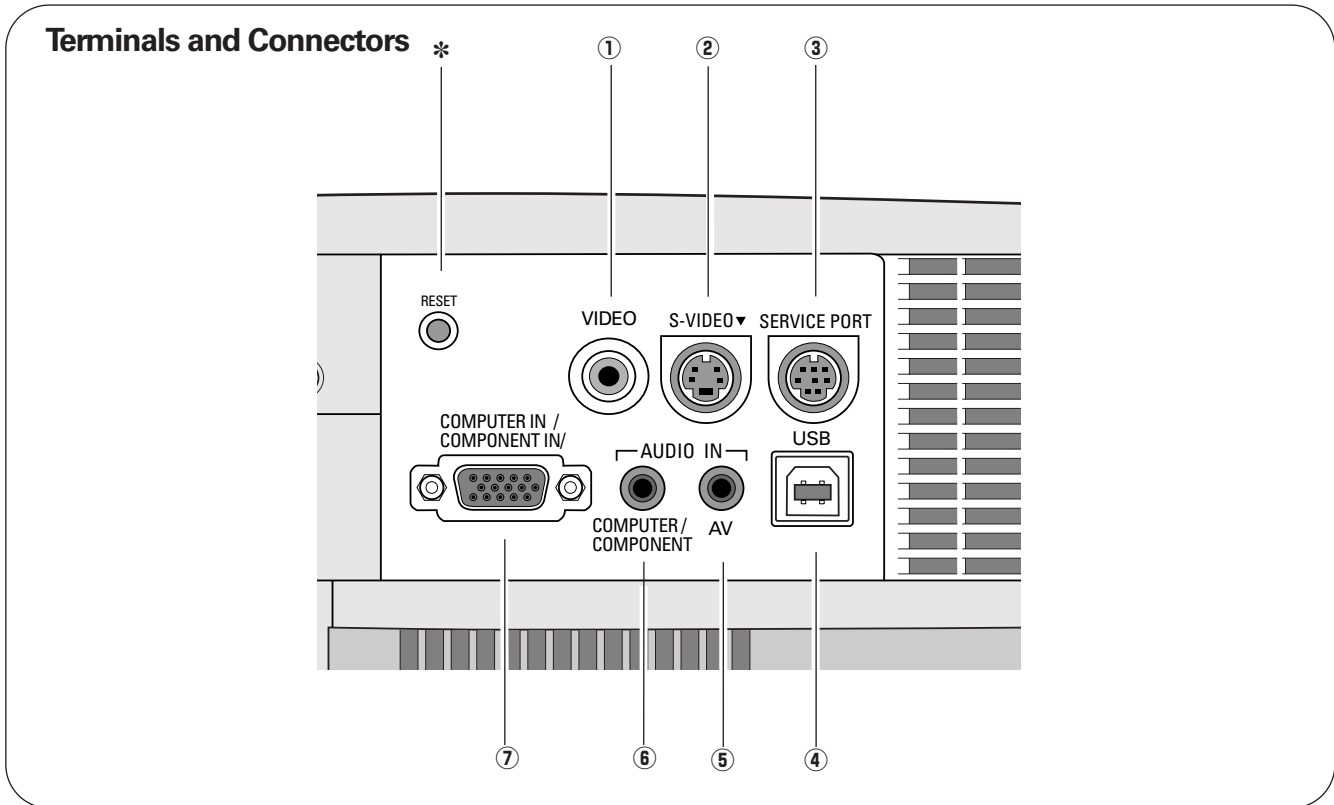

① VIDEO

Connect the composite video output from video equipment. (P16)

② S-VIDEO

Connect S-video output from video equipment. (P16)

③ SERVICE PORT

This jack is used to service this projector.

④ USB

Connect the USB port of your computer to this port when you want to use the PAGE ▲▼ buttons on the remote control to scroll back and forth pages on the screen of the connected computer. (P15, P38)

⑤ AUDIO IN AV

Connect audio output from video equipment. (P16)

⑥ AUDIO IN COMPUTER/ COMPONENT

Connect audio output from a computer or component to this jack. (P15, P16)

⑦ COMPUTER IN / COMPONENT IN

Connect computer output, component output or RGB Scart 21-pin video output to this connector. (P15, P16)

*** RESET button**

A microprocessor included in the projector may occasionally malfunction and need to be reset. If necessary, press this button with a sharp tool to restart the unit. Do not use it excessively.

Top Controls and Indicators

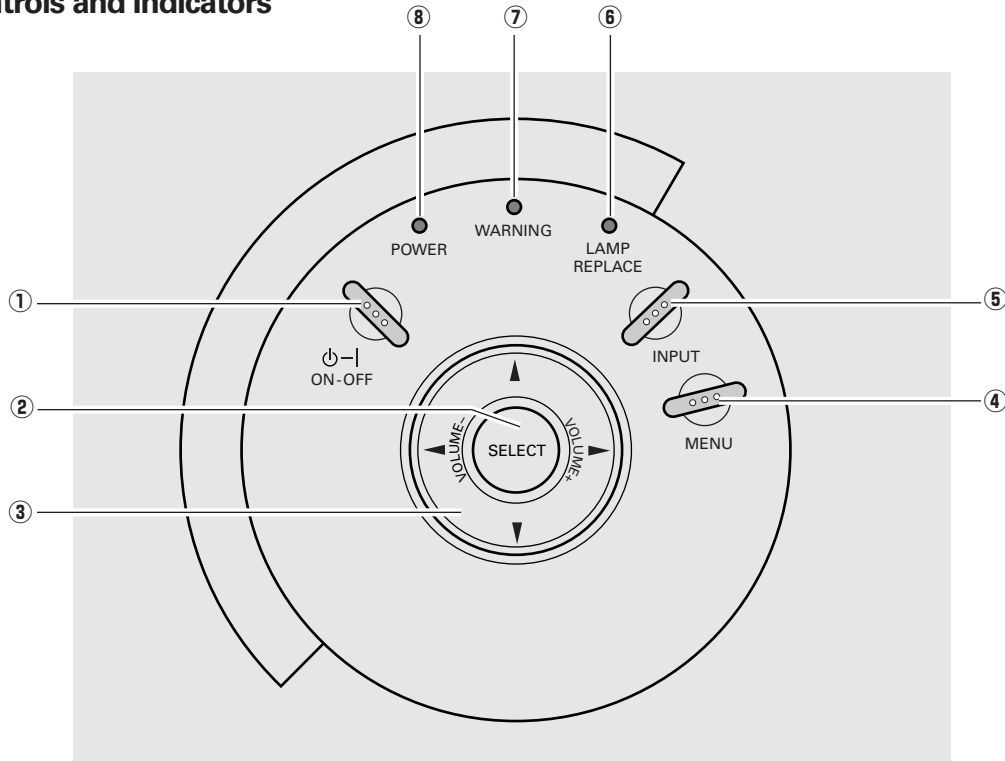

① POWER ON-OFF button

Turn the projector on or off. ([P17](#))

② SELECT button

- Execute the selected item. ([P18](#))
- Expand / compress the image in Digital Zoom mode. ([P29](#))

③ Point ▲▼◀▶ (VOLUME +/-) buttons

- Select an item or adjust the value in the On-Screen Menu. ([P18](#))
- Pan the image in Digital zoom +/- mode. ([P29](#))
- Adjust volume level. (the Point ◀▶ buttons) ([P21](#))

④ MENU button

Open or close the On-Screen Menu. ([P18](#))

⑤ INPUT button

Select the input source. ([P22, 30, 31](#))

⑥ LAMP REPLACE indicator

Turn yellow when the life of the projection lamp draws to an end. ([P42, 46](#))

⑦ WARNING indicator

Light red when the projector is in the abnormal condition. This indicator also flashes red when the internal projector temperature goes up over the operating range. ([P39, 46](#))

⑧ POWER indicator

Flash red until the projector gets ready to be turned on. It turns red when the projector is in the stand-by mode. It remains green while the projector is in operation. ([P17, 46](#))

Remote Control

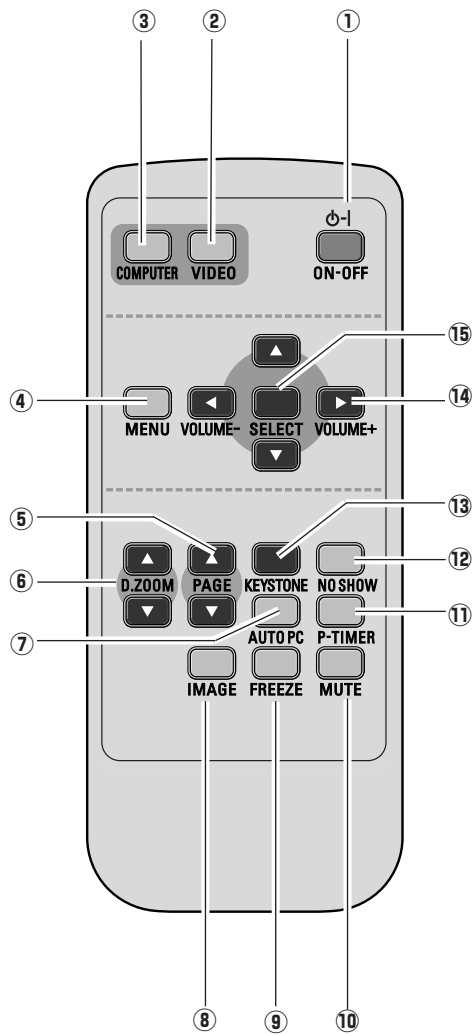

- ① **POWER ON-OFF button**
Turn the projector on or off. (P17)
- ② **VIDEO button**
Select VIDEO input source. (P30)
- ③ **COMPUTER button**
Select COMPUTER input source. (P22, P31)
- ④ **MENU button**
Open or close the On-Screen Menu. (P18)
- ⑤ **PAGE ▲▼ buttons**
Scroll back and forth pages on the screen when giving a presentation. (P9, P38)
- ⑥ **D.ZOOM ▲▼ buttons**
Select the Digital zoom +/- mode and resize the image. (P29)
- ⑦ **AUTO PC button**
Automatically adjust a computer image to its optimum setting. (P24)
- ⑧ **IMAGE button**
Select the image level. (P27, P33)
- ⑨ **FREEZE button**
Freeze the picture. (P20)
- ⑩ **MUTE button**
Mute the sound. (P21)
- ⑪ **P-TIMER button**
Operate the P-timer function. (P21)
- ⑫ **NO SHOW button**
Temporarily turn off the image on the screen. (P21)
- ⑬ **KEYSTONE button**
Correct keystone distortion. (P20, P36)
- ⑭ **POINT ▲▼◀▶ (VOLUME + / -) buttons**
 - Select an item or adjust the value in the On-Screen Menu. (P18)
 - Pan the image in Digital zoom +/- mode. (P29)
 - Adjust the volume level. (the Point Left/Right buttons) (P21)
- ⑮ **SELECT button**
 - Execute the selected item. (P18)
 - Expand / compress the image in Digital zoom mode. (P29)



To insure safe operation, please observe the following precautions :

- Do not bend, drop the remote control, or expose the Remote Control to moisture or heat.
- For cleaning, use a soft dry cloth. Do not apply benzene, thinner, splay or any chemical material.

Operating Range

Point the remote control toward the projector (Infrared Remote Receiver) when pressing any button. Maximum operating range for the remote control is about 16.4' (5m) and 60° in front of the projector.

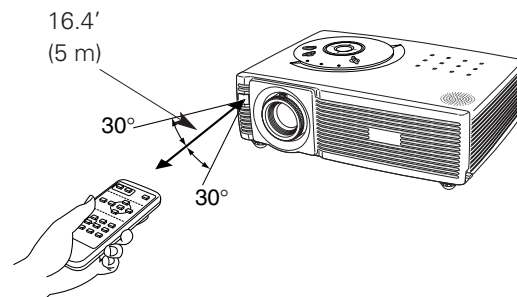

Remote Control Battery Installation

- 1** Remove the battery compartment lid.

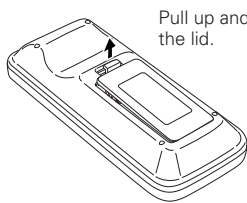

- 2** Slide the batteries into the compartment.

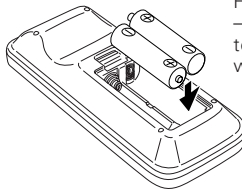

Two AAA size batteries
For correct polarity (+ and -), be sure battery terminals are in contact with pins in compartment.

- 3** Replace the compartment lid.

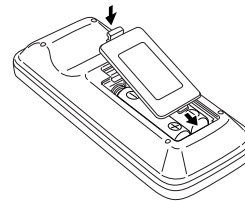

To insure safe operation, please observe the following precautions :

- Use (2) AAA, SUM-4 or LR03 type alkaline batteries.
- Replace two batteries at the same time.
- Do not use a new battery with a used battery.
- Avoid contact with water or liquid.
- Do not expose the remote control to moisture, or heat.
- Do not drop the remote control.
- If a battery has leaked on the remote control, carefully wipe case clean and install new batteries.
- Risk of an explosion if battery is replaced by an incorrect type.
- Dispose of used batteries according to the instructions.

Installation

Positioning the Projector

- This projector is designed to project on a flat projection surface.
- The projector can be focused from 4.3'(1.3m) to 21.3'(6.5m).
- Refer to the figure below to adjust the screen size.

$$A : B = 9 : 1$$

Note:

The brightness in a room has a great influence on the picture quality. It is recommended to limit ambient lighting in order to provide the best image.

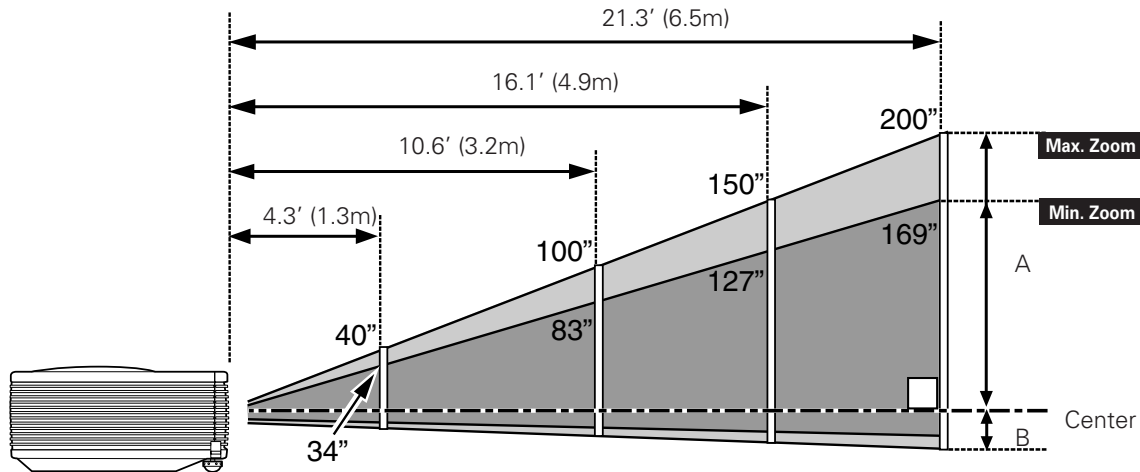

Screen Size (W x H) mm 4 : 3 aspect ratio	34"	40"	100"	150"	200"
Zoom (min)	4.3' (1.3m)	4.9' (1.5m)	12.5' (3.8m)	19.0' (5.8m)	—
Zoom (max)	—	4.3' (1.3m)	10.6' (3.2m)	16.1' (4.9m)	21.3' (6.5m)

Adjustable Feet

The picture tilt and the projection angle can be adjusted by rotating the adjustable feet. The projection angle can be adjusted at 8.0 degrees.

- 1 Lift the front of the projector and pull the feet lock latches on the both sides of the projector.
- 2 Release the feet lock latches to lock the adjustable feet and rotate them to adjust position and tilt.
- 3 To retract the adjustable feet, lift the front of the projector and pull and undo the feet lock latches.
Keystone distortion of the projected image can be adjusted by the Menu Operation. (P20, P36)

CAUTION

Tilt the projector within the adjustable angle not to shorten the lamp life. Proper angle should be taken.

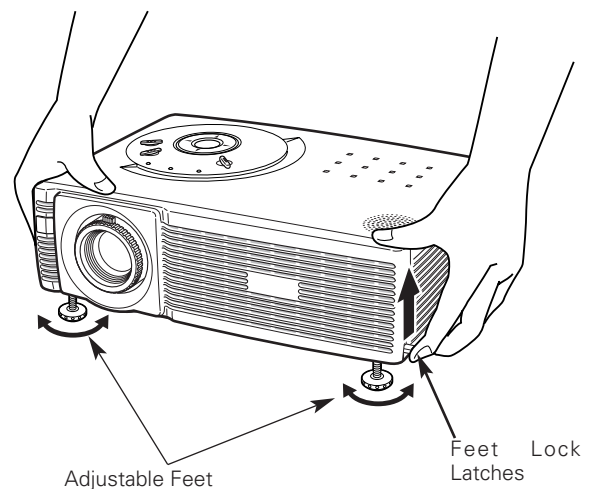

Connecting the AC Power Cord

This projector uses nominal input voltages of 100-120 V or 200-240 V AC. This projector automatically selects the correct input voltage. It is designed to work with single-phase power systems having a grounded neutral conductor. To reduce risk of electrical shock, do not plug into any other type of power system. Consult your authorized dealer or service station if you are not sure of the type of power supply being in use. Connect a projector with a peripheral equipment before turning a projector on. (Refer to page 15 –16 for connection.)



CAUTION

For safety, unplug the AC Power Cord when an appliance is not used. When this projector is connected to the outlet with the AC Power Cord, an appliance is in the Stand-by Mode and consumes a little electric power.

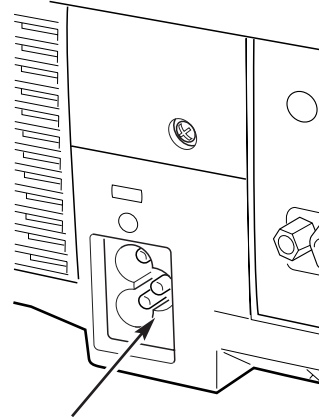

Connect the AC Power Cord (supplied) to the projector. The AC outlet must be near this equipment and must be easily accessible.

<p>Note: <i>The AC Power Cord must meet requirement of the country where you use the projector. Confirm an AC plug type with the chart below and proper AC Power Cord must be used. If supplied AC Power Cord does not match your AC outlet, contact your sales dealer.</i></p>		
<p>Projector side</p>	<p>AC Outlet side</p>	
<p>To POWER CORD CONNECTOR on your projector.</p>	<p>For the U.S.A. and Canada</p> <p>To the AC Outlet. (120 V AC)</p>	<p>For Continental Europe</p> <p>To the AC Outlet. (200 - 240 V AC)</p>

Connecting to a Computer

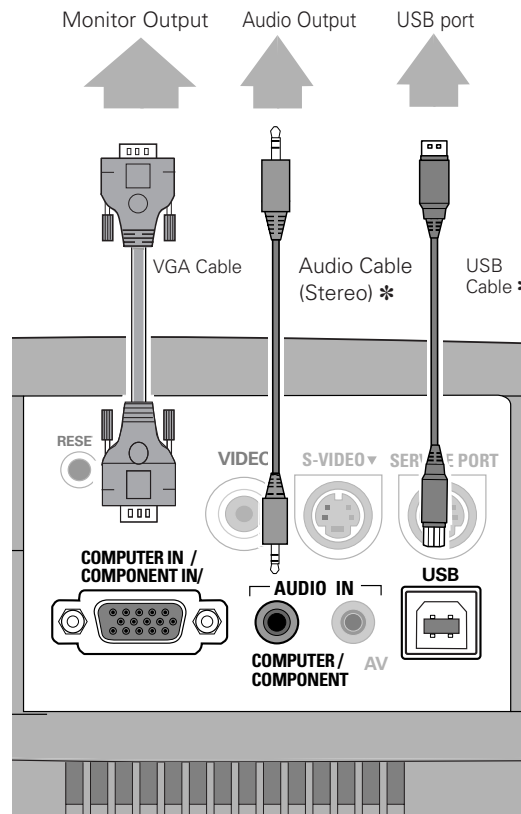
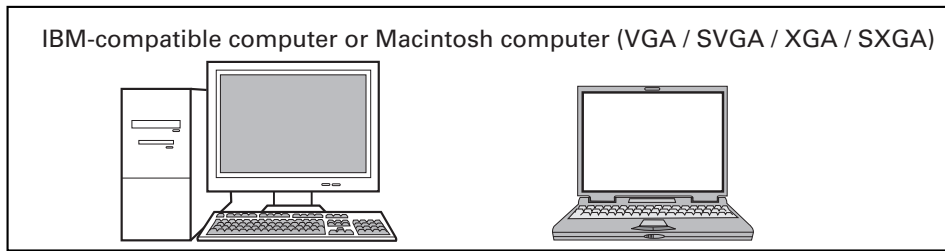

If you want to use the Page ▲▼ buttons on the remote control, connect USB port of your computer to the USB socket of the projector. (P38)

Cables used for connection

- VGA Cable (Mini D-sub 15 pin)
- Audio Cable (Mini Plug (stereo)) *
- USB Cable *

* Not supplied.

Note :

—See page 51 for ordering optional parts.



When connecting the cable, the power cords of both the projector and the external equipment should be disconnected from AC outlet. Turn the projector and peripheral equipment on before the computer is switched on.

Connecting to Video Equipment

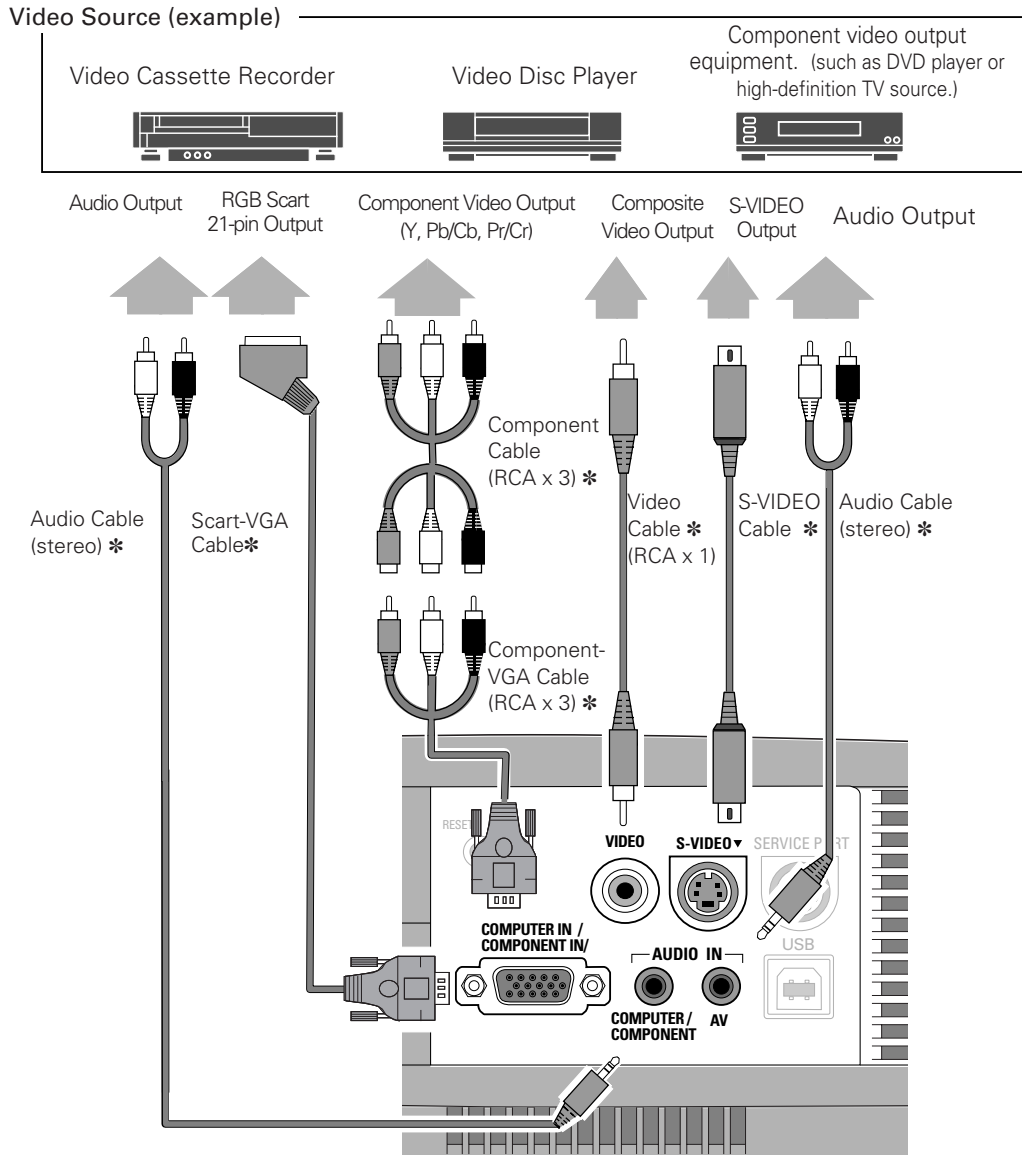

Cables used for connection

- Video Cable (RCA x 1) *
- S-VIDEO Cable *
- Audio Cables (Mini Plug) *
- Scart-VGA Cable *
- Component-VGA Cable (RCA x 3) *
- Component Cable (RCA x 3) *

* Not supplied.

Note :

–If both the S-VIDEO jack and the VIDEO jack are connected at the same time when AUTO is selected in the Input Menu, the S-VIDEO jack will override the signal from the VIDEO jack.
 –See page 51 for ordering optional parts.



When connecting the cable, the power cords of both the projector and the external equipment should be disconnected from AC outlet. Turn the projector and peripheral equipment on before the computer is switched on.

Turning On the Projector

- 1 Complete peripheral connections (with a computer, VCR, etc.) before turning on the projector.
- 2 Connect the projector's AC Power Cord into an AC outlet. The POWER indicator flashes in a moment and then turns red.
- 3 Press the POWER ON-OFF button on the top control or on the remote control. The POWER indicator turns green, and the cooling fans start to operate. The starting display appears on the screen and the count-down starts.
- 4 After the count-down, the input source that was selected last and the Lamp mode status appear on the screen.



- The starting display disappears after 30 seconds.
- The starting display can be changed. ("Capture" P36)

Selected Input Source and Lamp Mode

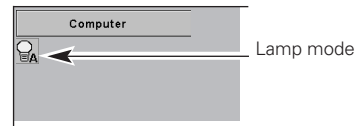

("Lamp mode" P37)

Turning Off the Projector

- 1 Press the POWER ON-OFF button on the top control or on the remote control, and the message " Power off? " appears on the screen.
- 2 Press the POWER ON-OFF button again to turn off the projector. The POWER indicator starts to flash red and continues while the cooling fans are operating. (for approx. 90 seconds)
- 3 When the projector is cooled down enough to be turned on again, the Power indicator turns red again. Then you can disconnect the AC power cord.

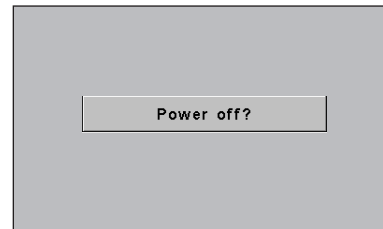

Message disappears after 4 seconds.



TO MAINTAIN THE LIFE OF LAMP, ONCE YOU TURN PROJECTOR ON, WAIT AT LEAST 5 MINUTES BEFORE TURNING IT OFF.
DO NOT DISCONNECT THE AC POWER CORD WHILE COOLING FANS ARE RUNNING OR BEFORE POWER INDICATOR LIGHTS RED. OTHERWISE IT WILL RESULT IN SHORTENING LAMP LIFE.

Note :

- When the Power Management function is ON, the projector detects signal interruption and automatically turns off the projection lamp. (P 37)
- The projector cannot be turned on during the cooling period with the POWER indicator flashing red. You can turn it on again after the POWER indicator lights red.
- Do not use the projector for more than 24 hours continuously. Turn off the projector at least once in 24 hours and give it a rest. Continuous use may result in shortening the lamp lifetime.
- This projector detects internal temperature and automatically controls the running speed of the cooling fans.
- If the WARNING indicator flashes or lights red, see "Warning Indicator" on page 39.

How to Operate the On-Screen Menu

The projector can be adjusted or set via the On-Screen Menu. Refer to the following pages regarding each adjustment and setting procedure.

- 1** Press the MENU button to display the On-Screen Menu.
- 2** Press the Point◀▶ buttons to select a Menu icon to adjust. Press the Point▲▼ buttons to select an item to adjust.
- 3** Press the SELECT button to show the item data. Press the Point◀▶ buttons to adjust the data. Refer to the following pages for respective adjustment.

Note:

–The selected item is not in active until the SELECT button is pressed.

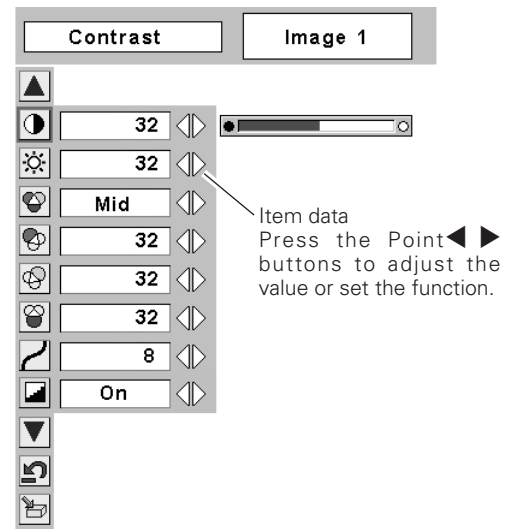
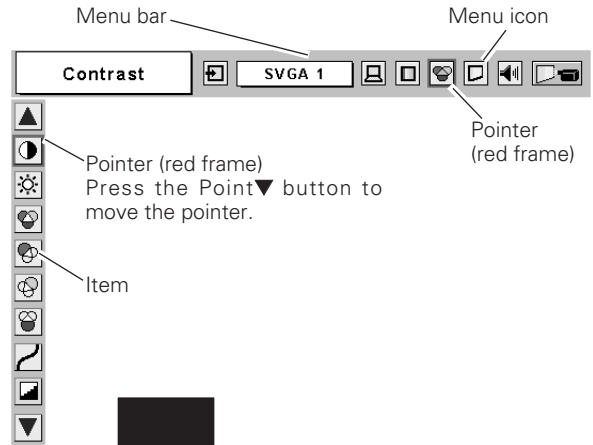

Remote Control

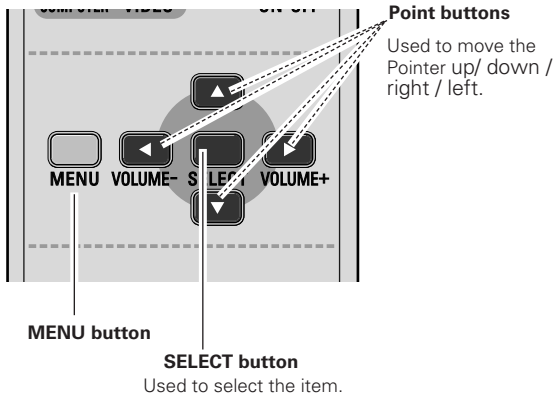

Top Control

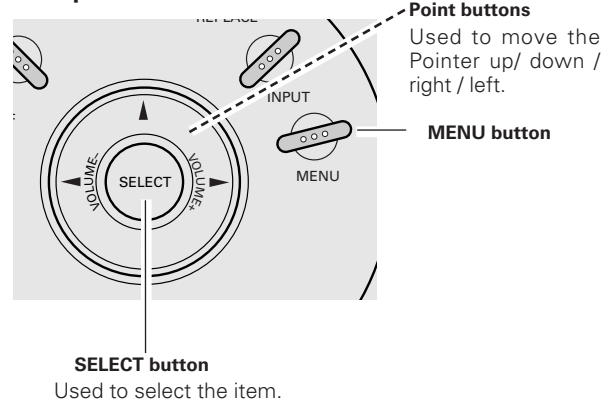

Menu Bar

For Computer Source

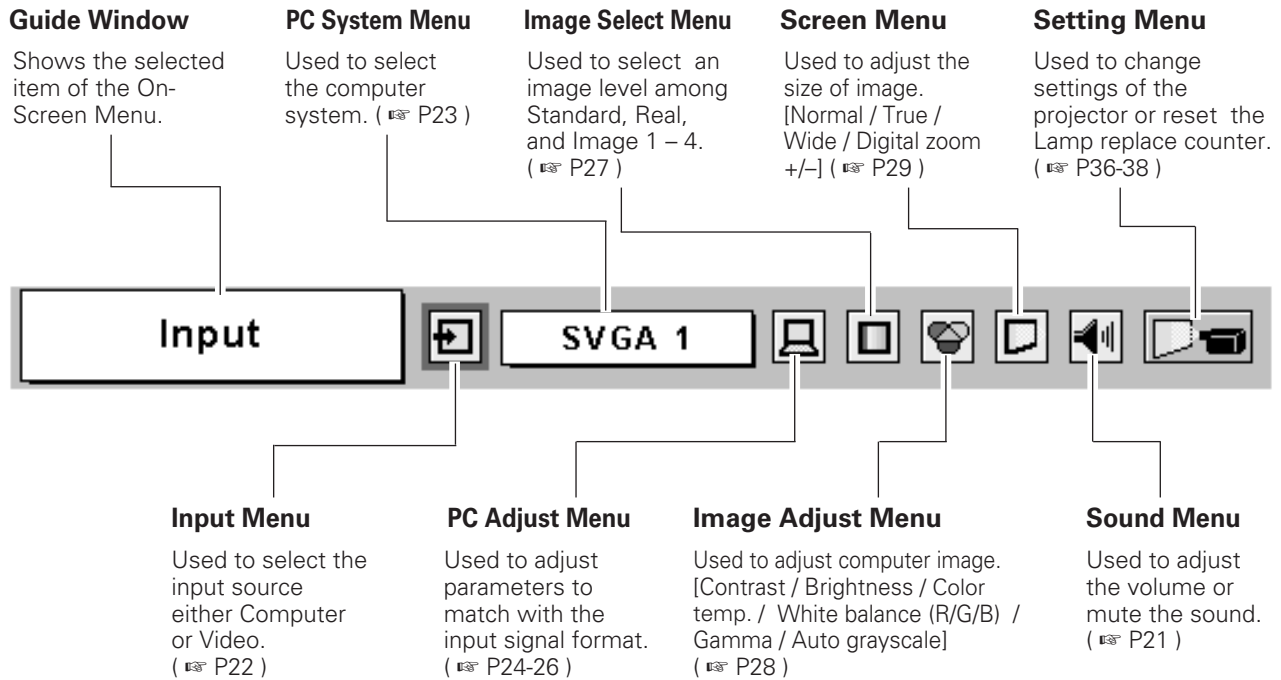

For video source

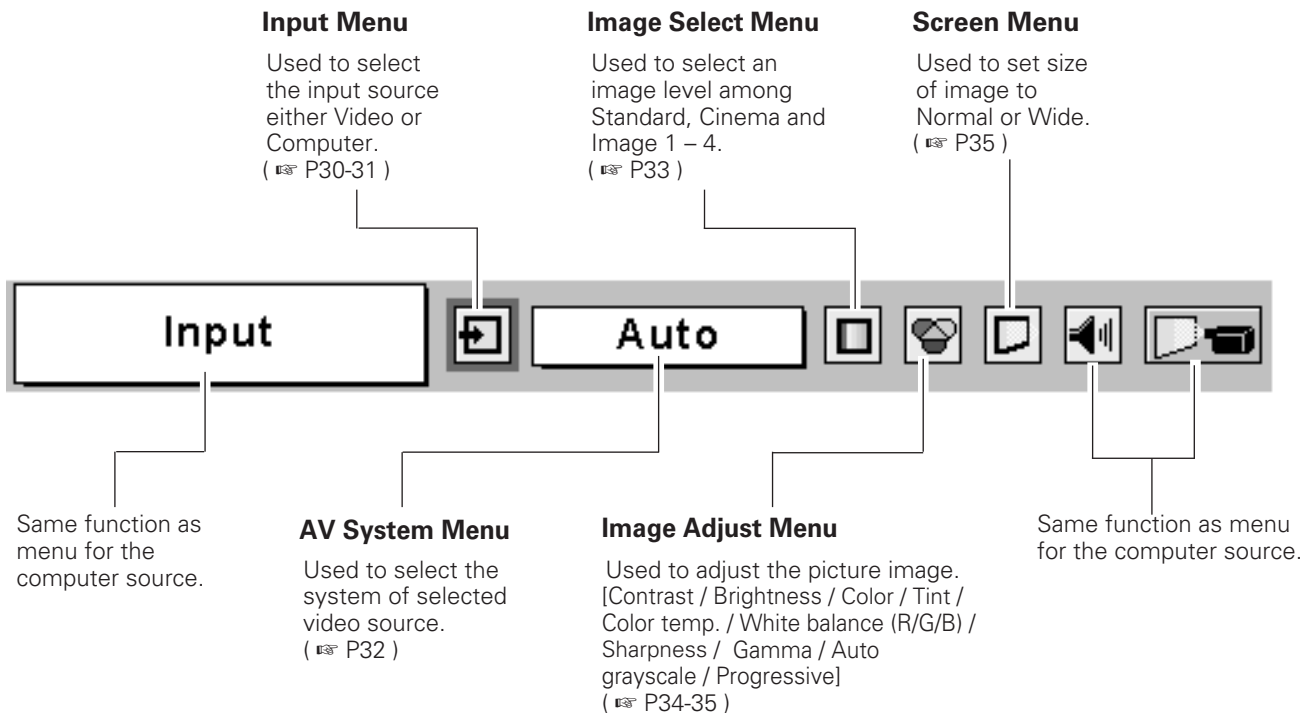

Zoom Adjustment

Move the Zoom Lever upward / downward to zoom the image.

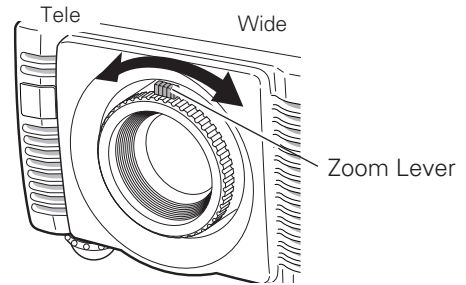

Focus Adjustment

Rotate the Focus Ring to adjust the projected picture focus.

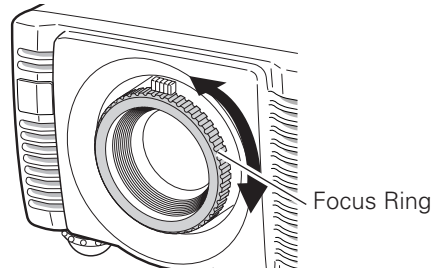

Keystone Adjustment

If a projected picture has keystone distortion, correct image with the Keystone adjustment.

- 1 Press the KEYSTONE button on the remote control or select Keystone on the Setting menu (P36) to display the Keystone dialog box.
- 2 Correct keystone distortion by pressing the Point ▲▼ buttons. Press the Point▲ button to reduce the upper part of image, and Press the Point▼ button to reduce the lower part.



- Arrows are white in no correction.
- The arrow of direction being corrected turns red.
- The arrow disappears at the maximum correction.
- If you press the KEYSTONE button on the remote control once more while the keystone dialog box is being displayed, the adjustment will be canceled.

Reduce the upper width with the Point ▲ button.

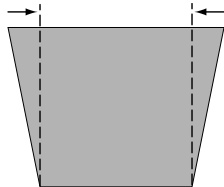

Reduce the lower width with the Point ▼ button.

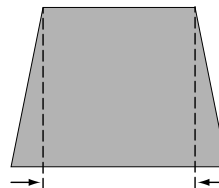

Picture Freeze Function

Press the FREEZE button on the remote control to freeze the picture on-screen. To cancel the Freeze function, press the FREEZE button again or press any other button.

No Show Function

Press the NO SHOW button on the remote control to black out the image. To restore to normal, press the NO SHOW button again or press any other button. When a projected image is captured and set as "User" in the Logo item in the Setting menu (P36), the screen changes each time you press the NO SHOW button as follows :

black out → the captured image → normal →……

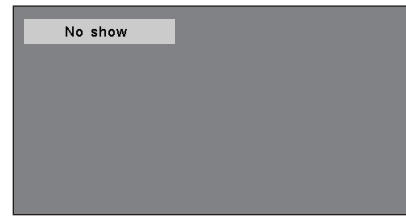

Message disappears after 4 seconds.

P-Timer Function

Press the P-TIMER button on the remote control. The timer display "00 : 00" appears on the screen and the timer starts to count time (00 : 00 ~ 59 : 59).

To stop P-Timer display, press the P-TIMER button. And then, press the P-TIMER button again to cancel P-Timer function.



Sound Adjustment

Direct Operation

Volume

Press the VOLUME +/- buttons on the remote control or on the top control to adjust volume. The volume dialog box appears on the screen for a few seconds.

The VOLUME + button to increase volume, and the VOLUME - button for decreasing.

Mute

Press the MUTE button on the remote control to cut off sound. To restore sound to its previous level, press the MUTE button again or press Volume +/-.

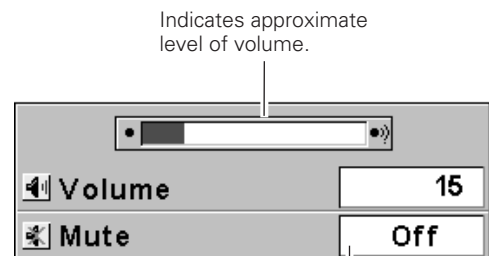

Indicates approximate level of volume.

Press the MUTE button to set Mute function "On" or "Off".

The display disappears after 4 seconds.

Menu Operation

1 Press the MENU button to display the On-Screen Menu. Press the Point ◀▶ buttons to move the red frame pointer to Sound Menu icon.

2 Press the Point ▼ button to move the red frame pointer to the item that you want to select, and then press the SELECT button.



To increase volume, Press the Point ▶ button, and Press the Point ◀ button to decrease volume.



Press the Point ◀▶ buttons to mute the sound. Dialog box display is changed to "On" and sound is muted. To restore sound to its previous level, press the Point ◀▶ buttons again.

SOUND MENU

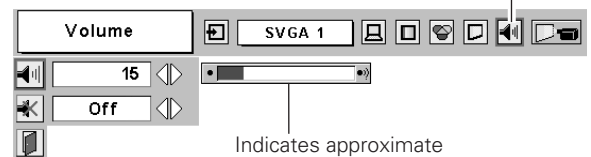

Sound Menu icon

Indicates approximate level of volume.

Close Sound Menu.

Computer Input

Input Source Selection

Direct Operation

Choose Computer by pressing the INPUT button on the top control or the COMPUTER button on the remote control.

Before using these buttons, correct input source should be selected through menu operation as described below.

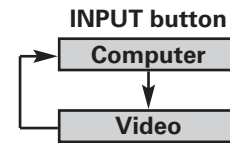

Menu Operation

- 1 Press the MENU button to display the On-Screen Menu. Press the Point ◀▶ buttons to move the red frame pointer to Input Menu icon.
- 2 Press the Point ▼ button to move the red arrow pointer to Computer and then press the SELECT button. The Source Select Menu will appear.
- 3 Move the pointer to the correct input source and press the SELECT button.

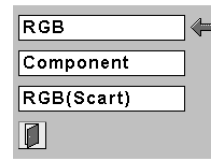
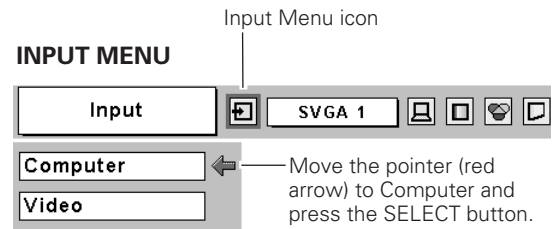

Source Select Menu

Move the pointer to RGB and press the SELECT button.

RGB When the input source is coming from a computer through the COMPUTER IN / COMPONENT IN terminal, select RGB.

Component See P31"Input Source Selection (Component, RGB-Scart 21-pin) ".

RGB (Scart) See P31" Input Source Selection (Component, RGB-Scart 21-pin) ".

Computer System Selection

This projector automatically tunes to various types of computers based on VGA, SVGA, XGA or SXGA with its Multi-scan system and Auto PC Adjustment. If Computer is selected as a signal source, this projector automatically detects the signal format and tunes to project a proper image without any additional setting. (Signal formats provided in this projector is shown on page 49)

Note : The projector may display one of the following messages.

- Auto**

When projector cannot recognize connected signal as PC system provided in this projector, Auto PC Adjustment function operates to adjust projector and the message "Auto" is displayed on the System Menu icon. When image is not provided properly, manual adjustment is required. (P25 - 26)
- There is no signal input from computer. Make sure the connection of computer and a projector is set correctly. (" Troubleshooting" P44)
- Mode 1**

User preset adjustment in Computer Adjustment. Adjustment data can be stored in Mode 1 - 5. (P25-26)
- SVGA 1**

Computer systems provided in the projector. The projector chooses a proper system and displays it.

*Mode 1 and SVGA 1 are examples.

Selecting Computer System Manually

PC system can be also selected manually.

- 1** Press the MENU button to display the On-Screen Menu. Press the Point ◀▶ buttons to move the red frame pointer to PC System Menu icon.
- 2** Press the Point ▼ button to move the red arrow pointer to the system that you want to set, and then press the SELECT button.

PC SYSTEM MENU

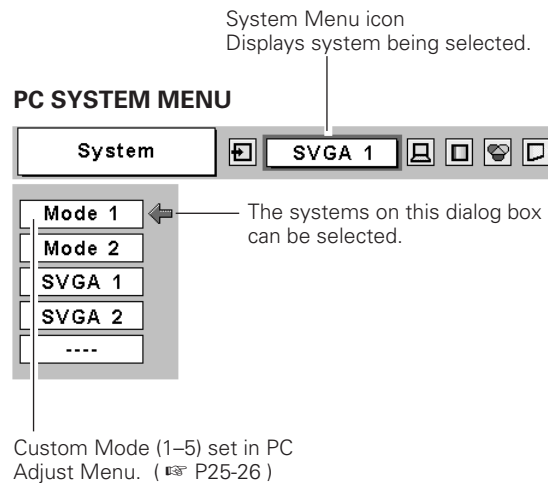
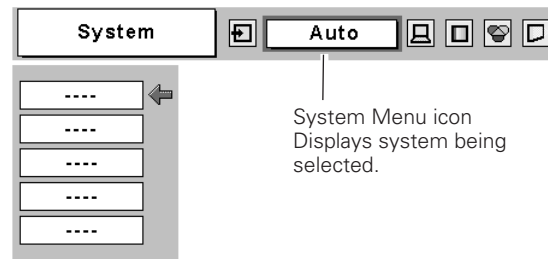

Auto PC Adjustment

Auto PC Adjustment function is provided to automatically conform Fine sync, Total dots and Picture Position to your computer. This function can be operated as follows.

Auto PC Adj.

- 1** Press the MENU button to display the On-Screen Menu. Press the Point ◀▶ buttons to move the red frame pointer to the PC Adjust Menu icon.
- 2** Press the Point ▼ button to move the red frame pointer to the Auto PC Adj. icon and then press the SELECT button twice. This Auto PC Adjustment can be also executed by pressing the Auto PC button on the remote control.

To store adjustment parameters :

Adjustment parameters from Auto PC Adjustment can be memorized in this projector. Once parameters are memorized, the setting can be done just by selecting Mode in PC System Menu (P23). Refer to " Store " of Manual PC Adjustment section (P26).

Note :

- Fine sync, Total dots and Picture Position of some computers can not be fully adjusted with this Auto PC Adjustment function. When the image is not provided properly through this function, manual adjustments are required. (P25, 26)
- Auto PC Adjustment function cannot be operated when 480p, 575p, 480i, 575i, 720p (HDTV), 1035i (HDTV) or 1080i (HDTV) is selected on PC SYSTEM Menu. (P23).

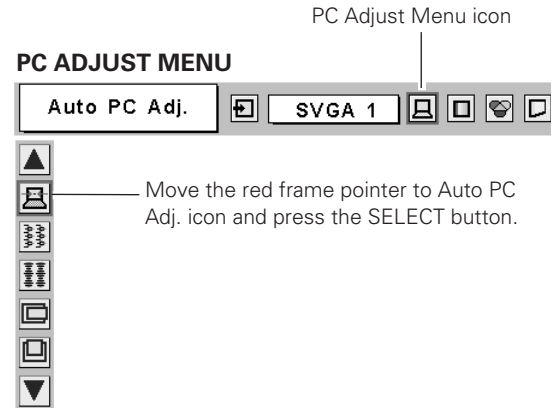

Manual PC Adjustment

Some computers employ special signal formats which may not be tuned by Multi-Scan system of this projector. In this case, the projector cannot reproduce a proper image and the image may be recognized as a flickering picture, a non-synchronized picture, a non-centered picture or a skewed picture.

The Manual PC Adjustment function allows you to precisely adjust several parameters to match those special signal formats. You can store those adjusted parameters in the 5 independent memory areas, enabling you to call up whenever you need.

1 Press the MENU button to display the On-Screen Menu. Press the Point ◀▶ buttons to move the red frame pointer to the PC Adjust Menu icon.

2 Press the Point ▼ button to move the red frame pointer to the item that you want to adjust and then press the SELECT button to display the adjustment dialog box. Press the Point ◀▶ buttons to adjust the value.



Fine sync

Adjust an image as necessary to eliminate flicker from the display. Press the Point ◀▶ buttons to adjust the value. (From 0 to 31.)



Total dots

Adjust the number of total dots in one horizontal period. Press the Point ◀▶ buttons and adjust number to match your PC image.



Horizontal

Adjust horizontal picture position. Press the Point ◀▶ buttons to adjust the position.



Vertical

Adjust vertical picture position. Press the Point ◀▶ buttons to adjust the position.



Current mode

Press the SELECT button to show the information of computer selected.



Clamp

Adjust clamp level. When the image has dark bars, try this adjustment.

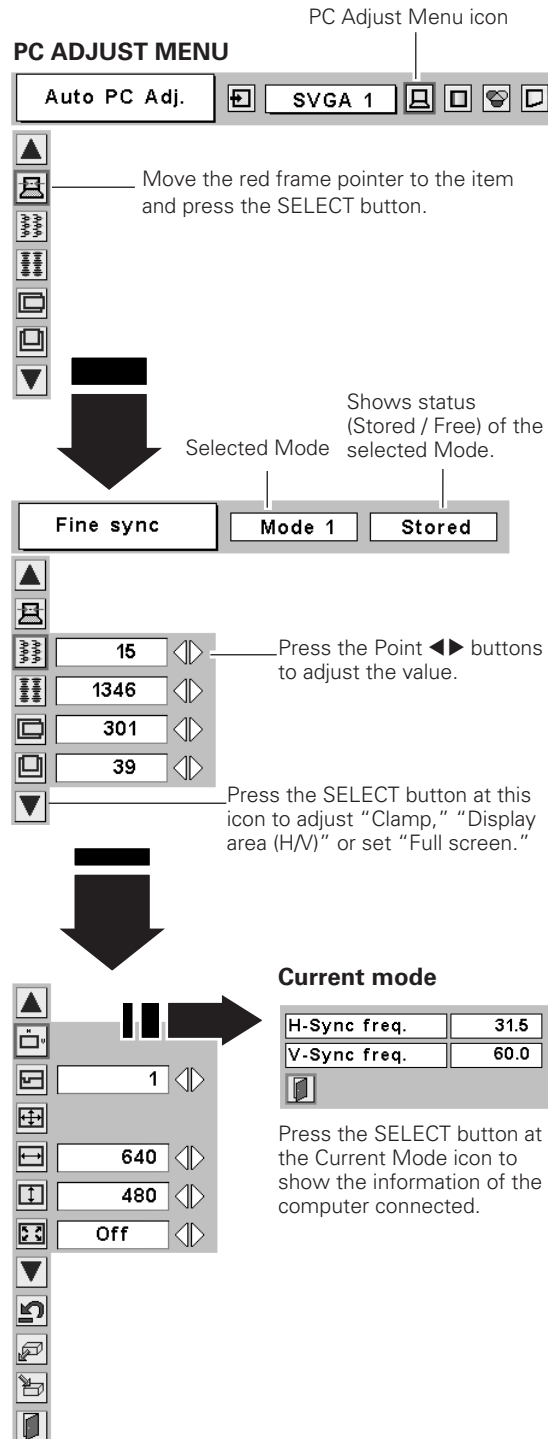

Computer Input

Display area

Select area displayed with this projector. Select the resolution at the Display area dialog box.

Display area H

Adjust the horizontal area displayed with this projector. Press the Point ◀▶ buttons to decrease/increase value to match the resolution of image. Then press the SELECT button.

Display area V

Adjust the vertical area displayed with this projector. Press the Point ◀▶ buttons to decrease / increase the value to match the resolution of the image. Then press the SELECT button.

Full screen

Press the Point ◀▶ buttons to switch Full screen function to "On" or "Off." Set "On" to resize the image with 4 x 3 aspect ratio to fit the screen.

Note:

Display area, Display area (H/V) and Full screen cannot be adjusted when 480p, 575p, 480i, 575i, 720i(HDTV), 1035i(HDTV) or 1080i(HDTV) is selected on PC SYSTEM Menu. (P23).

Reset

Reset all adjust parameters on adjustment dialog box to previous figures.

Mode free

To clear adjustment parameters previously set, move the red frame pointer to the Mode free icon and then the SELECT button. Move the red arrow pointer to the Mode that you want to clear and then press the SELECT button.

Store

To store adjustment parameters, move the red frame pointer to the Store icon and then press the SELECT button. Move the red arrow pointer to any of Mode 1 to 5 that you want to store to and then press the SELECT button.

Quit

Close PC Adjust Menu.

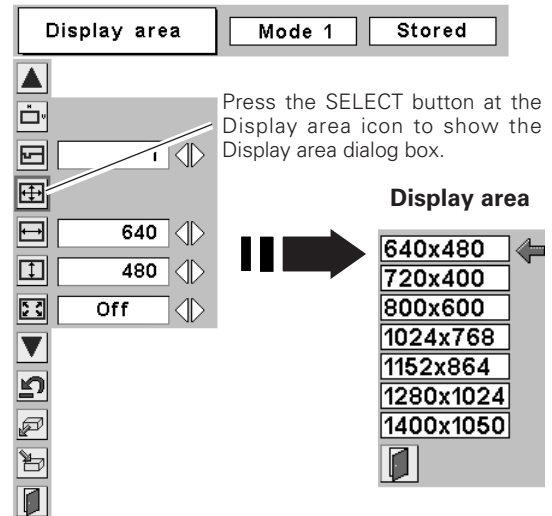

To clear adjustment data

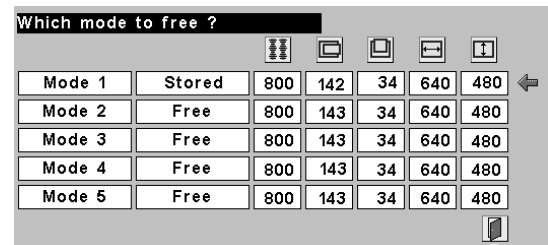

Close this dialog box.

To store adjustment data

This Mode has parameters being stored.

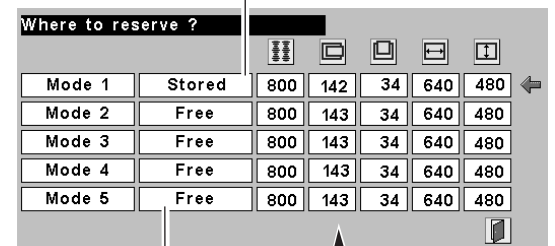

Vacant Mode

Shows values of "Total dots," "Horizontal," "Vertical," "Display area H," and "Display area V."

Image Level Selection

Direct Operation

Select image level among Standard, Real, Image 1, Image 2, Image 3 and Image 4 by pressing the IMAGE button on the remote control.

Standard

Normal picture adjustment preset on this projector.

Real

Picture adjustment improved in reproduction of halftones. This adjustment is suitable for providing better image in brighter place.

Image 1~4

User preset picture adjustment in Image Adjust Menu (P28).

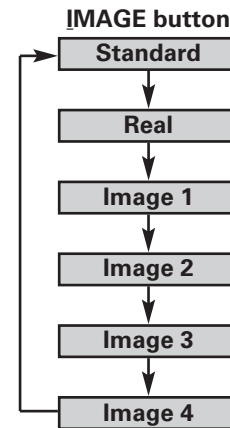

Menu Operation

- 1 Press the MENU button to display the On-Screen Menu. Press the Point ◀▶ buttons to move the red frame pointer to the Image Select Menu icon.
- 2 Press the Point ▼ button to move the red frame pointer to the level that you want to set and then press the SELECT button.

Standard

Normal picture adjustment preset on this projector.

Real

Picture adjustment improved in reproduction of halftones. This adjustment is suitable for providing better image in brighter place.

Image 1~4

User preset picture adjustment in Image Adjust Menu (P28).

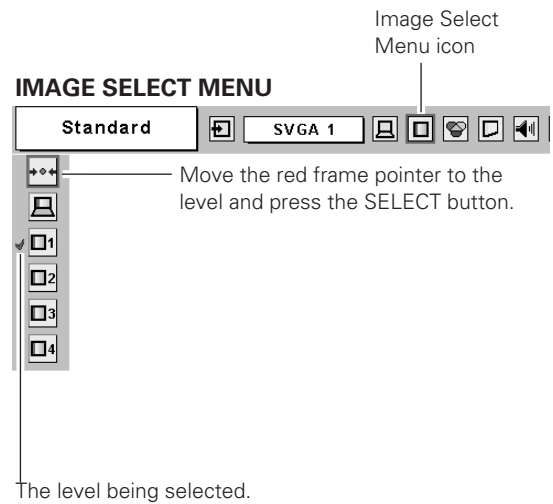

Image Level Adjustment

- 1 Press the MENU button to display the On-Screen Menu. Press the Point ◀▶ buttons to move the red frame pointer to the Image Adjust Menu icon.
- 2 Press the Point ▼ button to move the red frame pointer to the item that you want to adjust, and then press the SELECT button. The level of each item is displayed. Adjust each level by pressing the Point ◀▶ buttons.



Contrast

Press the Point ◀▶ buttons to adjust the image contrast. (From 0 to 63.)



Brightness

Press the Point ◀▶ buttons to adjust the image brightness. (From 0 to 63.)



Color temp.

Press the Point ◀▶ buttons to select the Color temp. level you want to select. (XLow, Low, Mid, or High)



White balance (Red)

Press the Point ◀▶ buttons to adjust the red tone. (From 0 to 63.)



White balance (Green)

Press the Point ◀▶ buttons to adjust the green tone. (From 0 to 63.)



White balance (Blue)

Press the Point ◀▶ buttons to adjust the blue tone. (From 0 to 63.)



Gamma

Press the Point ◀▶ buttons to obtain better balance of contrast. (From 0 to 15.)



Auto grayscale

When this function is "On", it automatically enhances contrast of bright and dark part of the image.



Reset

Reset all adjustments to previous figures.



Store

To store manually preset image, move the red frame pointer to the Store icon and press the SELECT button to display the Image Level Menu. Move the red frame pointer to the Image 1 to 4 where you want to set and then press the SELECT button. A confirmation box will appear and select "Yes".



Quit

Close the Image Adjust Menu.

Image Adjust Menu icon

IMAGE ADJUST MENU

Move the red frame pointer to the item to be selected and then press the SELECT button.

Selected Image level

Contrast Image 1

Press the Point ◀▶ buttons to adjust the value.

Store icon
Press the SELECT button at this icon to store the adjustment.

Image Level Menu
Move the red frame pointer to any of Image 1 to 4 where you want to set and then press the SELECT button.

OK ?
Yes
No

Screen Size Adjustment

This projector has a picture screen resize function, which enables you to customize the image size.

- 1 Press the MENU button to display the On-Screen Menu. Press the Point ◀▶ buttons to move the red frame pointer to the Screen Menu icon.
- 2 Press the Point ▼ button to move the red frame pointer to the function that you want to select. Then press the SELECT button.

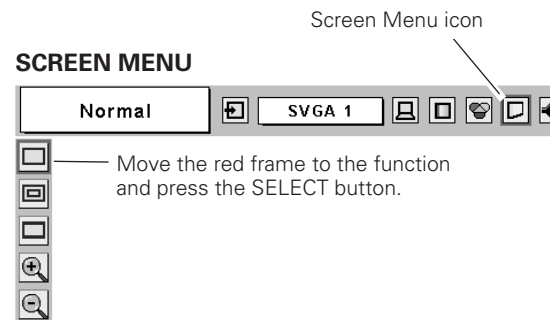

Normal

Provide an image to fit the screen size.

True

Provide image in its original size. When the original image size is larger than screen size (800 x 600), this projector enters "Digital zoom +" mode automatically.

Wide

Provide image to fit wide video aspect ratio (16 : 9) by expanding image width uniformly. This function can be used for providing a squeezed video signal at 16 : 9.

Digital zoom +

When Digital zoom + is selected, the On-Screen Menu disappears and the message "D. Zoom +" is displayed. Press the SELECT button to expand image size. And press the Point ▲▼◀▶ buttons to pan the image. The panning function can work only when the image is larger than screen size.

A projected image can be also expanded by pressing the D.ZOOM ▲ button on the remote control.

Digital zoom -

When Digital zoom - is selected, the On-Screen Menu disappears and the message "D. Zoom -" is displayed. Press the SELECT button to compress image size.

A projected image can be also compressed by pressing the D.ZOOM ▼ button on the remote control.

To cancel Digital zoom +/- mode, press any button except the D.ZOOM ▲▼ buttons, the SELECT and the Point buttons.

Note:

- This Screen Menu cannot be operated when 720p(HDTV), 1035i(HDTV) or 1080i(HDTV) is selected on PC System Menu. (P23).
- True and Digital zoom +/- cannot be selected when 480i, 575i, 480p, 575p is selected on PC System Menu. (P23).
- This projector cannot display any resolution higher than 1280 X 1024. If your computer's screen resolution is higher than 1280 X 1024, reset the resolution to the lower before connecting projector.
- The image data in other than SVGA (800 x 600) is modified to fit the screen size in initial mode.
- The panning function may not operate properly if the computer system prepared on PC Adjust Menu is used.

Video Input

Input Source Selection (Video, S-Video)

Direct Operation

Choose Video by pressing the INPUT button on the top control or the VIDEO button on the remote control.

Before using these buttons, correct input source should be selected through menu operation as described below.

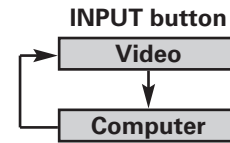

Menu Operation

- 1 Press the MENU button to display the On-Screen Menu. Press the Point ◀▶ buttons to move the red frame pointer to the Input Menu icon.
- 2 Press the Point ▼ button to move the red arrow pointer to Video and then press the SELECT button. Source Select Menu will appear.
- 3 Move the pointer to the source that you want to select and then press the SELECT button.

Auto When selecting Auto, the projector automatically detects incoming video signal, and adjusts itself to optimize its performance. The projector selects connection in the following order:

- 1st S-VIDEO
- 2nd VIDEO

If both the S-VIDEO jack and the VIDEO jack are connected at the same time when Auto is selected in the Input Menu, the S-VIDEO jack will override the signal from the VIDEO jack.

Video When video input signal is connected to VIDEO jack, select Video.

S-Video When video input signal is connected to S-VIDEO jack, select S-Video.

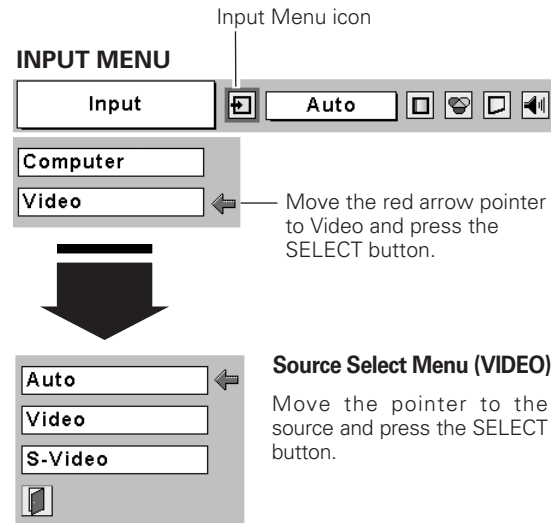

Input Source Selection (Component, RGB Scart 21-pin)

Direct Operation

Choose Computer by pressing the INPUT button on the top control or the COMPUTER button on the remote control.

Before using these buttons, correct input source should be selected through menu operation as described below.

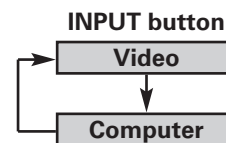

Menu Operation

- 1 Press the MENU button to display the On-Screen Menu. Press the Point ◀▶ buttons to move the red frame pointer to the Input Menu icon.
- 2 Press the Point ▼ button to move the red arrow pointer to Computer and then press the SELECT button. The Source Select Menu will appear.
- 3 Move the pointer to the source that you want to select and then press the SELECT button.

Component

When the input source is coming from video equipment connected to the COMPUTER IN /COMPONENT IN terminal with a Component-VGA Cable, select Component.

RGB (Scart)

When the input source is coming from video equipment connected to the COMPUTER IN /COMPONENT IN terminal with a Scart-VGA Cable, select RGB (Scart).

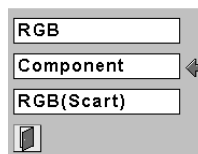
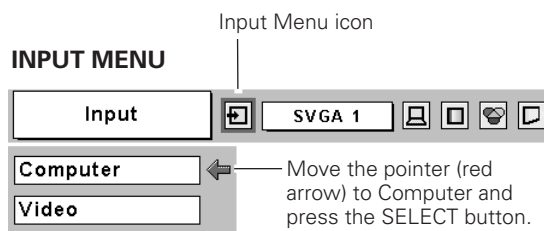

Source Select Menu

Move the pointer to Component or RGB (Scart) and press the SELECT button.

Note :

–Component-VGA Cable and Scart-VGA Cable are optionally supplied. See page 51 for order.

Video System Selection

- 1 Press the MENU button to display the On-Screen Menu. Press the Point ◀▶ buttons to move the red frame pointer to the AV System Menu icon.
- 2 Press the Point ▼ button to move the red arrow pointer to the system that you want to select and then press the SELECT button.

Video Jack or S-Video Jack

Auto

The projector automatically detects incoming video system, and adjusts itself to optimize its performance.
When Video System is PAL-M or PAL-N, select the system manually.

PAL / SECAM / NTSC / NTSC4.43 / PAL-M / PAL-N

If projector cannot reproduce proper video image, it is necessary to select a specific broadcast signal format among PAL, SECAM, NTSC, NTSC4.43, PAL-M, and PAL-N.

AV SYSTEM MENU (VIDEO OR S-VIDEO)

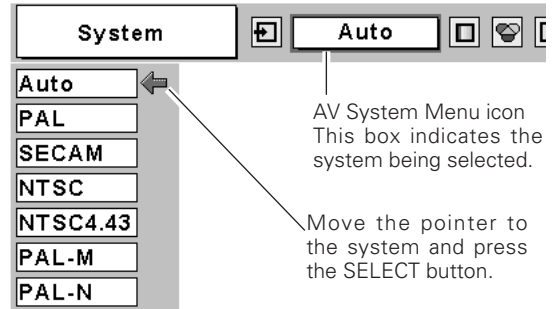

COMPUTER IN / COMPONENT IN Jack (Y, Pb/Cb, Pr/Cr)

Auto

The projector automatically detects incoming Video signal, and adjusts itself to optimize its performance.

COMPONENT VIDEO SIGNAL FORMAT

If the projector cannot reproduce proper video image, it is necessary to select a specific component video signal format among 480i, 575i, 480p, 575p, 720p, 1035i and 1080i.

AV SYSTEM MENU (COMPONENT VIDEO)

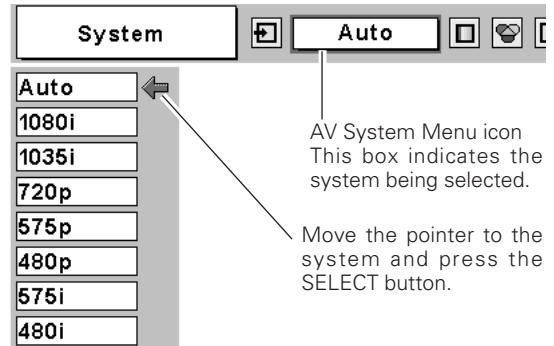

Image Level Selection

Direct Operation

Select image level among Standard, Cinema, Image 1, Image 2, Image 3 and Image 4 by pressing the IMAGE button on the remote control.

Standard

Normal picture adjustment preset on this projector.

Cinema

Picture level adjusted for the picture with fine tone.

Image 1~4

User preset picture adjustment in Image Adjust Menu (P34-35).

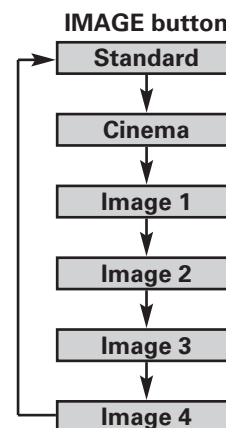

Menu Operation

1 Press the MENU button to display the On-Screen Menu. Press the Point ◀▶ buttons to move the red frame pointer to the Image Select Menu icon.

2 Press the Point ▼ button to move the red frame pointer to the level that you want to set and then press the SELECT button.



Standard

Normal picture adjustment preset on this projector.



Cinema

Picture level adjusted for the picture with fine tone.



Image 1~4

User preset picture adjustment in Image Adjust Menu (P34-35).

IMAGE SELECT MENU

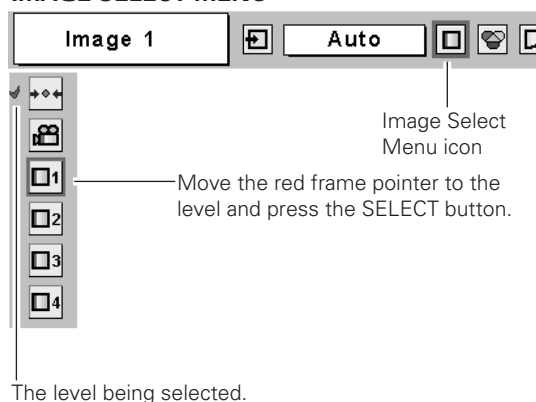

Image Level Adjustment

- 1 Press the MENU button to display the On-Screen Menu. Press the Point ◀▶ buttons to move the red frame pointer to the Image Adjust Menu icon.
- 2 Press the Point ▼ button to move the red frame pointer to the item you want to adjust and then press the SELECT button. The level of each item is displayed. Adjust each level by pressing the Point ◀▶ buttons.



Contrast

Press the Point ◀▶ buttons to adjust the image contrast. (From 0 to 63.)



Brightness

Press the Point ◀▶ buttons to adjust the image brightness. (From 0 to 63.)



Color

Press the Point ◀▶ buttons to adjust color intensity. (From 0 to 63.)



Tint

Press the Point ◀▶ buttons to obtain proper color. (From 0 to 63.)



Color temp.

Press the Point ◀▶ buttons to select the Color temp. level that you want to select. (XLow, Low, Mid, or High)



White balance (Red)

Press the Point ◀▶ buttons to adjust the red tone. (From 0 to 63.)



White balance (Green)

Press the Point ◀▶ buttons to adjust the green tone. (From 0 to 63.)



White balance (Blue)

Press the Point ◀▶ buttons to adjust the blue tone. (From 0 to 63.)



Sharpness

Press the Point ◀▶ buttons to adjust the image sharpness. (From 0 to 15.)



Gamma

Press the Point ◀▶ buttons to obtain better balance of contrast. (From 0 to 15.)

Note :

–Tint cannot be selected when the video system is PAL, SECAM, PAL-M or PAL-N.

IMAGE ADJUST MENU

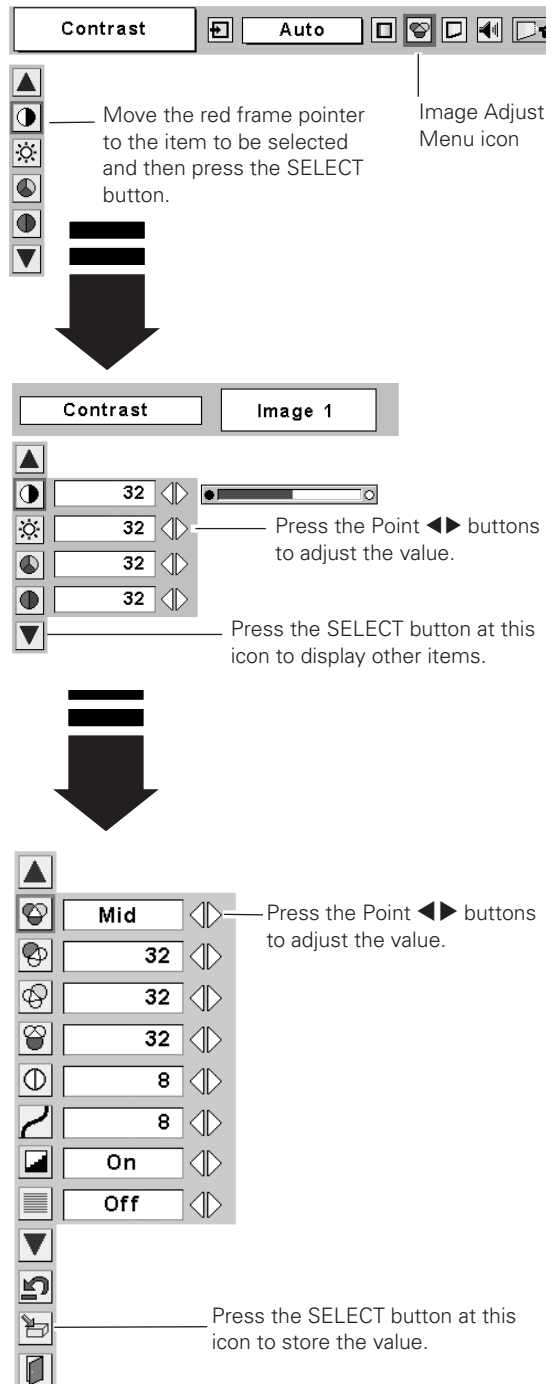

Auto grayscale

When this function is "On", it automatically enhances contrast of bright and dark part of image.

progressive

Interlace video signal can be displayed in a progressive picture.

Off Not activated.

L1 Select "L1" for an active picture.

L2 Select "L2" for a still picture.

Note : *The Progressive cannot be selected when 1080i, 1035i, 720p, 575p, or 480p is selected.*

Reset

Reset all adjustments to previous figures.

Store

To store the adjusted data, move the red frame pointer to the Store icon and press the SELECT button to display the Image Level Menu. Move the red frame pointer to the Image Level 1 to 4 and then press the SELECT button.

A confirmation box will appear and select [Yes].

Quit

Close the Image Menu.

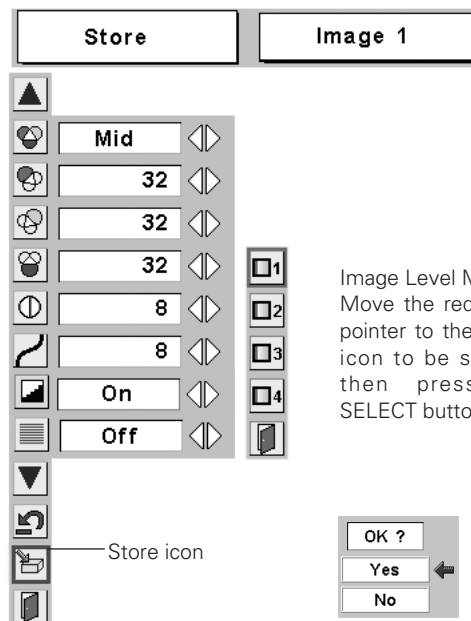

Screen Size Adjustment

This projector has a picture screen resize function, which enables you to customize the image size.

- 1 Press the MENU button to display the On-Screen Menu. Press the Point ◀▶ buttons to move the red frame pointer to the Screen Menu icon.
- 2 Press the Point ▼ button and move the red frame pointer to the function that you want to select and then press the SELECT button.

SCREEN MENU



Normal

Provides image at a normal video aspect ratio of 4 : 3.

Wide

Provides image at a wide screen ratio of 16 : 9.

Note:

–The Screen Menu cannot be operated when 720p, 1035i, or 1080i is selected on the AV System Menu (P32).

Setting Menu

- 1 Press the MENU button to display the On-Screen Menu. Press the Point ◀▶ buttons to move the red frame pointer to the SETTING icon.
- 2 Press the Point ▼ button to move the red frame pointer to the item that you want to set. Then press the SELECT button to display the Setting dialog box.

Language

Language used in the On-Screen Menu is selectable from among English, German, French, Italian, Spanish, Portuguese, Dutch, Swedish, Russian, Chinese, Korean and Japanese.

Keystone

This function corrects distortion of a projected image. Select either Store or Reset with the Point ◀▶ buttons, and then press the Select button. The keystone dialog box appears. Adjust keystone with the Point ▲▼◀▶ buttons.

Store stores the keystone adjustment even if the AC power cord is disconnected.

Reset resets the keystone adjustment when the AC power cord is disconnected.

Blue back

When this function is "On," the projector will project a blue image on the screen if any input signal is not detected.

Display

This function decides whether to display On-Screen Displays.

On show all the On-Screen Displays.

Off set On-Screen Displays disappeared except;

- On-Screen Menu
- "Power off?" message (P17)
- P-TIMER (P21)
- "No signal" message (P37)
- "Wait a moment!" message

Logo

This function decides what to be displayed on the starting display.

User the image you captured

Default the factory set logo

Off count-down only

Capture

This function is used to capture the image being projected and use it for a start-up display. After capturing the projected image, go to the Logo function (above) and set it as "User". Then the captured image will be displayed when turning on the projector next time.

To capture the image, select "Yes". To cancel the Capture function, select "No".

Before capturing an image, select Standard in the Image Select Menu to capture a proper image. (P27, P33)

A signal from a computer can be captured up to XGA (1024 x 768).

A signal from video equipment can be captured except for 720p, 1035i, and 1080i. When capturing the image that has been adjusted by Keystone function, the adjusted data is automatically reset and the projector captures an image without keystone adjustment.

SETTING MENU

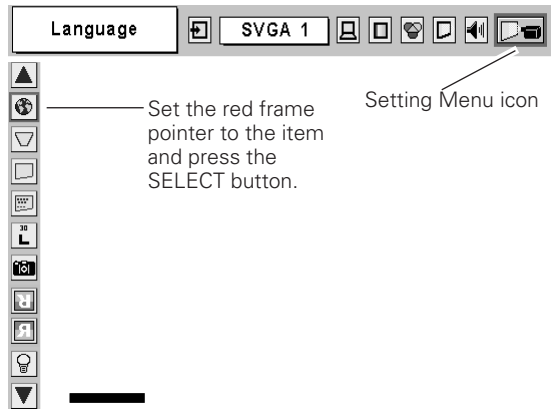

Set the red frame pointer to the item and press the SELECT button.

Setting Menu icon

Press the SELECT button at Language to show the Language Menu.

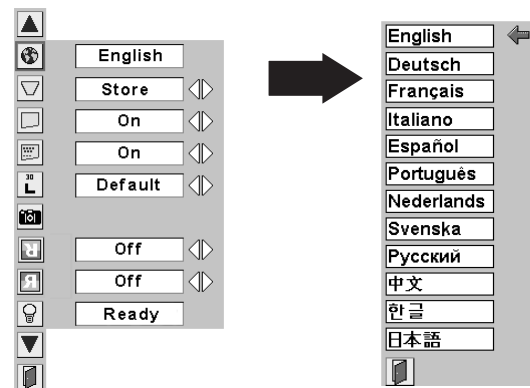

Capture

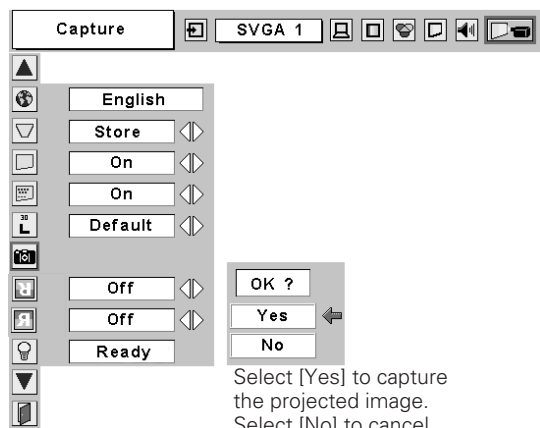

Select [Yes] to capture the projected image. Select [No] to cancel.

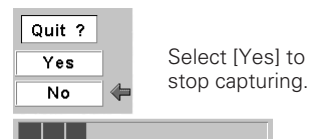

Select [Yes] to stop capturing.

Ceiling

When this function is "On", picture is top / bottom and left / right reversed. This function is used to project the image from a ceiling mounted projector.

Rear

When this function is "On", picture is left / right reversed. This function is used to project the image to a rear projection screen.

Power management

For reducing power consumption as well as maintaining the lamp life, Power management function turns off the projection lamp when the input signal is interrupted and no button is pressed for 30 seconds or more.

If the input signal is interrupted and no button is pressed for 30 seconds or more, the timer display with the message " No signal" appears on the screen. The count-down of the set time will get started. The count-down time can be set between 1 and 30 minutes.

When the count-down time has been elapsed, the lamp will be turned off to cool itself down. The POWER indicator is flashing red during this cooling-off period. The next operation depends on the setting as follows :

- Ready When the lamp has been fully cooled down, the POWER indicator changes to green flashing. In this condition, the projection lamp will be turned on if the input signal is reconnected or any button on the top control or the remote control is pressed.
- Shutdown When the lamp has been fully cooled down, the power will be turned off.
- Off Power management function is canceled.

Lamp mode

This function allows you to change brightness of the screen.

- Normal modenormal brightness
- Auto modethe controlled brightness according to the input signal
- Eco modelowers brightness, reduces the lamp power consumption, and extends the lamp life.

Ceiling function

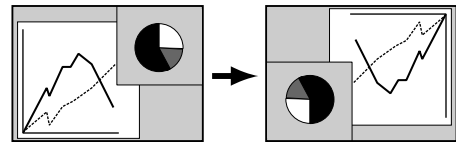

Rear function

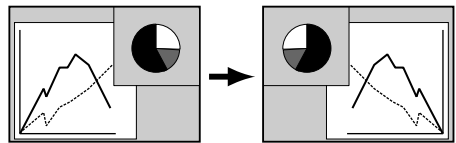

Power management

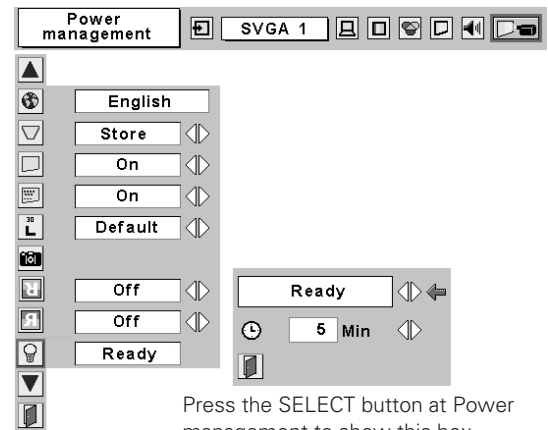

Press the SELECT button at Power management to show this box. Choose one of three settings with the Point ◀▶ buttons, and navigate to the timer with the Point ▲▼ buttons and set time with the Point ◀▶ buttons.



Time left until Lamp off

Lamp mode

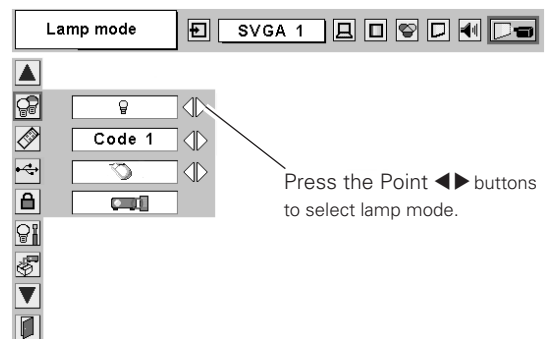

Remote control

This projector has two different remote control codes; the factory-set normal code (Code 1) and the secondary code (Code 2). This switching function prevents remote control interference when operating several projectors or video equipment at the same time. When operating the projector in "Code 2," both the projector and remote control must be switched to "Code 2."

To change the code of the projector :

Set the remote control in the SETTING MENU to "Code 2."

To change the code of the remote control :

Press and hold both the MENU and the IMAGE buttons on the remote control together for 10 seconds or more. After changing the code, make sure the remote control operates properly.



To return to the normal code (Code 1), operate both the projector and remote control in the ways above again.

Note :

—When battery of the remote control is replaced, the remote control code automatically returns to the normal code (Code 1).



USB

This projector is equipped with the USB port for interactive operation between the projector and computer. Select either of the followings as needed.

-  When using the PAGE ▲▼ buttons on the remote control. (P9)
-  When controlling the projector with a computer.
This item is provided for future use. Not available now.

Key lock

This function locks operation of the top control and the remote control. It is useful to prevent operation by a third person.

-  Not locked.
-  Lock the operation of the top control.
To unlock, use the remote control.
-  Lock the operation of the remote control.
To unlock, use the top control.

If the top control accidentally becomes locked and you do not have the remote control nearby, disconnect the AC power cord to turn off the power, and then while pressing the SELECT button, reconnect the AC power cord. This will unlock the top control operation.

Lamp counter reset

This function is used to reset the lamp replace counter. When replacing the projection lamp, reset the lamp replace counter by using this function. Refer to page 43 for operation.

Factory default

This function returns all setting values except for the lamp counter to the factory default settings.

Remote Control

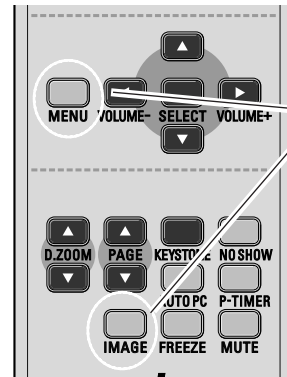

Press and hold the MENU and the IMAGE buttons for 10 seconds or more.

Key lock

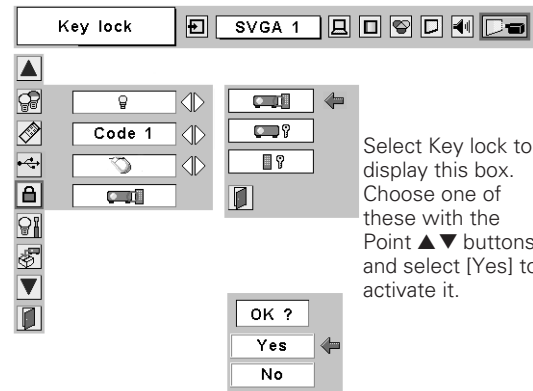

Select Key lock to display this box. Choose one of these with the Point ▲▼ buttons and select [Yes] to activate it.

Factory default

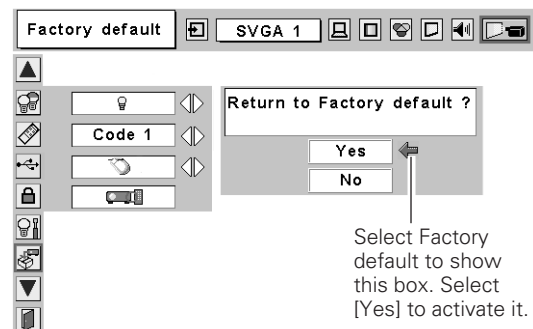

Select Factory default to show this box. Select [Yes] to activate it.

Maintenance and Cleaning

Warning Indicator

The WARNING indicator shows the state of the function which protects the projector. Check the state of the WARNING indicator and the POWER indicator to take proper maintenance.

The projector is shut down and the WARNING indicator is flashing red

When the temperature inside the projector exceeds the normal temperature, the projector is automatically shut down to protect the inside of the projector. The POWER indicator is flashing and the projector is being cooled down. When the temperature inside the projector returns to normal, the POWER indicator lights red and the projector can be turned on.

Note :

After the temperature inside the projector returns to normal, the WARNING indicator still continues to flash. When the projector is turned on again, the WARNING indicator stops flashing.

Then check the items below.

- ✓ Did you provide appropriate space for the projector to be ventilated? Check the installing condition to see if ventilation slots are not blocked.
- ✓ Is the projector not installed near the ventilation duct of air-conditioning equipment which may be hot? Install the projector away from the ventilation duct of air-conditioning equipment.
- ✓ Are the air filters clean? Clean the air filters periodically.

Top Control

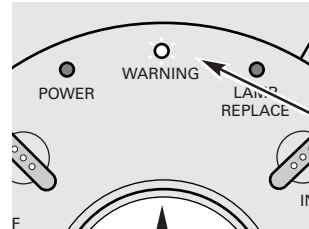

WARNING flashing red

The projector is shut down and the WARNING indicator lights red

When the projector detects an abnormal condition, it is automatically shut down to protect the inside and the WARNING indicator lights red. In this case, disconnect the AC power cord and reconnect it, and then turn the projector on once again for check. If the projector is still turned off and the WARNING indicator lights red, disconnect the AC power cord and contact the service station for check and repair.

Top Control

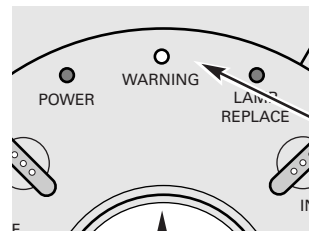

WARNING lights red



CAUTION

DO NOT LEAVE THE PROJECTOR WITH THE AC POWER CORD CONNECTED UNDER THE ABNORMAL CONDITION. IT MAY RESULT IN FIRE OR ELECTRIC SHOCK.

Air Filter

Removable air filters prevent dust from accumulating on the surface of optical elements inside the projector. Should air filters become clogged with dust particles, it will reduce the cooling fans' effectiveness and may result in internal heat build up and adversely affect the life of the projector. Clean air filters following the steps below:

- 1** Turn off the projector, and disconnect AC power cord from the AC outlet.
- 2** Turn the projector upside down and remove air filters by pulling the latches upward.
- 3** Clean the air filters with a brush or wash out dust and particles.
- 4** Replace each air filter properly. Make sure that the air filters are fully inserted.



CAUTION

Do not operate the projector with the air filters removed. Dust may accumulate on optical elements inside the projector degrading picture quality. Do not put small parts into Air Intake Vents. It may result in malfunction of the projector.

RECOMMENDATION

We recommend avoiding dusty/smoky environments when operating a projector. Usage in these environments may cause poor image quality.

When using under dusty or smoky conditions, dust may accumulate on or optical elements inside the projector. This condition may degrade the quality of a projected image.

When the above symptoms are noticed, contact your authorized dealer or service station for proper cleaning.

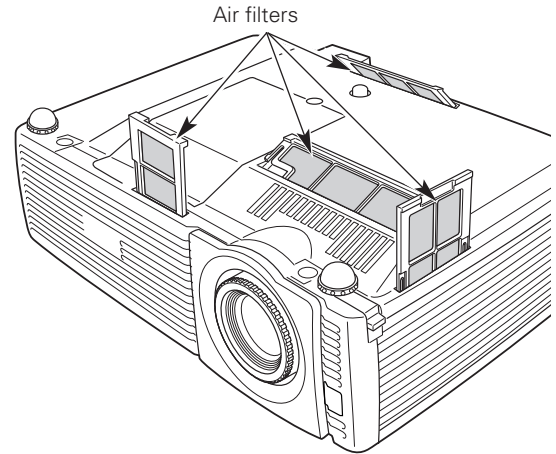

Attaching the Lens Cover

- 1** Thread the string through the hole on the lens cover and then tie a knot in the string to secure it in place.
- 2** Thread the other end of the string through the hole at the bottom of the projector. Then pass the lens cover through the resulting loop of the string. Tie a knot in the string to secure it in place.

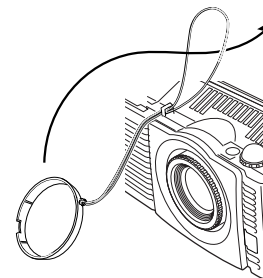
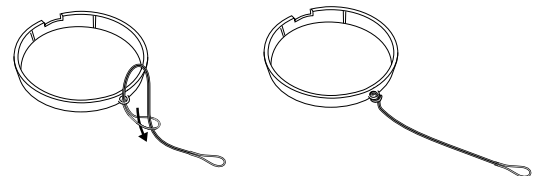

Cleaning the Projection Lens

Follow these steps to clean the projection lens:

- 1** Disconnect the AC power cord before cleaning.
- 2** Apply a non-abrasive camera lens cleaner to a soft, dry cleaning cloth. Avoid using an excessive amount of cleaner. Abrasive cleaners, solvents or other harsh chemicals might scratch a surface.
- 3** Lightly wipe Projection Lens with a cleaning cloth.
- 4** When the projector is not in use, replace the Lens Cover.

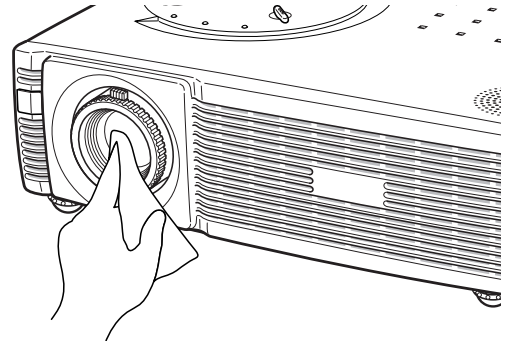

Cleaning the Projector Cabinet

Follow these steps to clean the projector cabinet.

- 1** Disconnect the AC power cord before cleaning.
- 2** Lightly wipe the projector body with a soft, dry cleaning cloth. When it is heavily soiled, use a small amount of mild detergent and finish with a soft, dry cleaning cloth. Avoid using an excessive amount of cleaner. Abrasive cleaners, solvents, or other harsh chemicals might scratch the surface.
- 3** When the projector is not in use, put the projector in an appropriate carrying case to protect it from being exposed to the dust and being scratched.

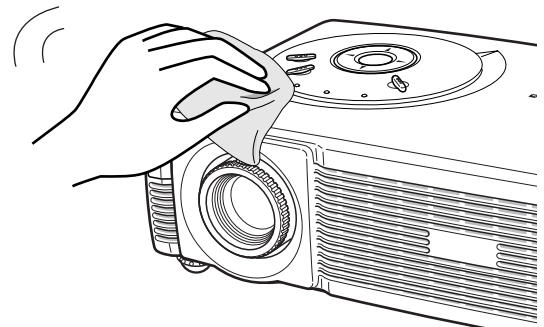

Lamp Replacement

When the life of the projection lamp draws to an end, LAMP REPLACE indicator lights yellow. If this indicator lights yellow, replace the projection lamp with a new one promptly.

TOP CONTROL

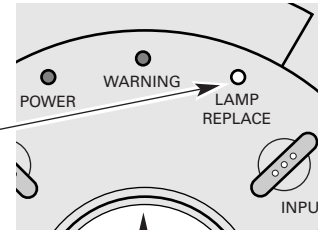

This indicator lights yellow when the life of the projection lamp draws to an end.



Allow the projector to cool, for at least 45 minutes before you open the Lamp Cover. The inside of the projector can become very hot.



CAUTION

For continued safety, replace with the lamp assembly of the same type.

Do not drop the lamp assembly or touch the glass bulb. The glass can shatter and may cause injury.

Follow these steps to replace the lamp assembly.

- 1** Turn off the projector and disconnect the AC plug. Allow the projector to cool at least for 45 minutes.
- 2** To remove the lamp cover, remove the screw with a screwdriver .
- 3** Remove two screws with a screwdriver and pull out the lamp assembly by grasping the handle.
- 4** Replace the lamp assembly with a new one and tighten the two screws back into the position. Make sure that the lamp assembly is set properly. Replace the lamp cover and tighten the screw.
- 5** Connect the AC Power Cord to the projector and turn on the projector.
- 6** **Reset the Lamp Replace Counter.**
Refer to "Lamp Replace Counter" on the next page .

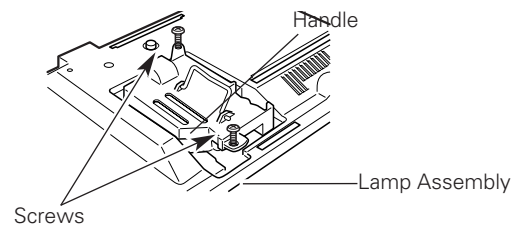
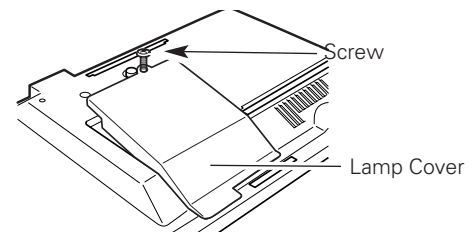

Note :

-Do not reset the Lamp Replace Counter when the projection lamp has not been replaced.

ORDER REPLACEMENT LAMP

Replacement Lamp can be ordered through your dealer. When ordering a projection lamp, give the following information to the dealer.

- **Model No. of your projector** : **LC-SD12**
- **Replacement Lamp Type No.** : **POA-LMP57**

(Service Parts No. 610 308 3117)

Lamp Replace Counter

Be sure to reset the lamp replace counter after Lamp Assembly is replaced. When the lamp replace counter is reset, the LAMP REPLACE Indicator stops lighting.

- 1 Turn projector on, press the MENU button to display the On-Screen Menu. Press the Point ◀▶ buttons to move the red frame pointer to the Setting Menu icon.
- 2 Press the Point ▼ button to move the red frame pointer to "Lamp counter reset" and then press the SELECT button. The message "Lamp replace counter reset?" is displayed. Move the pointer to [Yes] and then press the SELECT button.
- 3 Another confirmation dialog box appears and select [Yes] to reset the lamp replace counter.

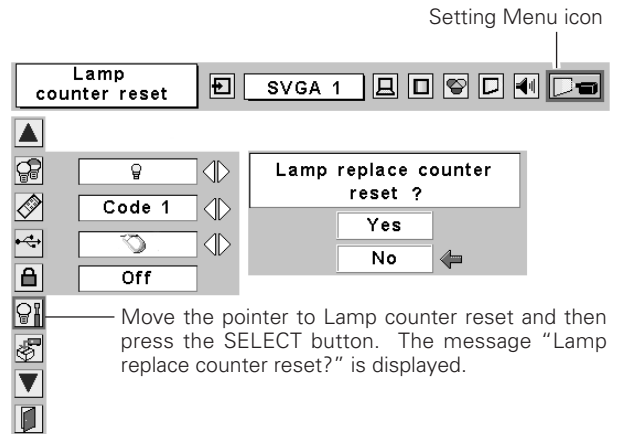

Note :

–Do not reset the Lamp Replace Counter until after the projection lamp is replaced.



LAMP HANDLING PRECAUTIONS

This projector uses a high-pressure lamp which must be handled carefully and properly. Improper handling may result in an accidents, injury, or create a fire hazard.

- Lamp lifetime may differ from lamp to lamp and according to the environment of use. There is no guarantee of the same lifetime for each lamp. Some lamps may fail or terminate their lifetime in a shorter period of time than other similar lamps.
- If the projector indicates that the lamp should be replaced, i.e., if the LAMP REPLACE INDICATOR lights up, replace the lamp with a new one IMMEDIATELY after the projector has cooled down.
(Follow carefully the instructions in the LAMP REPLACEMENT section of this manual.) Continuous use of the lamp with the LAMP REPLACE INDICATOR lighted may increase the risk of lamp explosion.
- A Lamp may explode as a result of vibration, shock or degradation as a result of hours of use as its lifetime draws to an end. Risk of explosion may differ according to the environment or conditions in which the projector and lamp are being used.

IF A LAMP EXPLODES, THE FOLLOWING SAFETY PRECAUTIONS SHOULD BE TAKEN.















If a lamp explodes, disconnect the projector’s AC plug from the AC outlet immediately. Contact an authorized service station for a checkup of the unit and replacement of the lamp. Additionally, check carefully to ensure that there are no broken shards or pieces of glass around the projector or coming out from the cooling air circulation holes. Any broken shards found should be cleaned up carefully. No one should check the inside of the projector except those who are authorized trained technicians and who are familiar with projector service. Inappropriate attempts to service the unit by anyone, especially those who are not appropriately trained to do so, may result in an accident or injury caused by pieces of broken glass.



Appendix

Troubleshooting

Before calling your dealer or service center for assistance, check the matters below once again.

- Make sure you have properly connected the projector to peripheral equipment as described in the section "Installation" on P15-16.
- Make sure all equipment is connected to AC outlet and turned on the power.
- When you operate the projector with a computer, and it does not project an image, restart the computer.

Problem:	- Try These Solutions
No power.	<ul style="list-style-type: none">- Plug the projector into your AC outlet.- Make sure if the POWER indicator lights red.- Wait 90 seconds after a projector is turned off when turning the projector back on. The projector can be turned on after the Power indicator turns red. ( "Turning Off the Projector " P17)- Check the WARNING indicator. If the indicator flashes red, the projector cannot be turned on. ( "Warning Indicator " P39)- Check the projection lamp. ( P42-43)- Unlock Key lock for the projector in the Setting Menu. ( P38)
Image is out of focus.	<ul style="list-style-type: none">- Adjust focus of the projector. ( P20)- Provide proper distance between the projector and projection screen. ( P13)- Check the projection lens to see if it needs cleaning. ( P41)- Moving the projector from a cool temperature location to a warm temperature location may result in moisture condensation on the projection lens. In this case, leave the projector off and wait until condensation evaporates.
Picture is Left/Right reversed.	<ul style="list-style-type: none">- Check Ceiling / Rear item. ( "Setting" on page 37)
Picture is Top/Bottom reversed.	<ul style="list-style-type: none">- Check Ceiling item. ( "Setting" on page 37)
Some displays are not seen during the operation.	<ul style="list-style-type: none">- Check Display item. ( "Setting" on page 36)
No image.	<ul style="list-style-type: none">- Check the connection between your computer or video equipment and the projector.- Check if the input signal is correctly output from your computer. Some laptop computers may need to change the setting for monitor output when connected to the projector. See the computer's owner's manual for its setting.- Check No Show function. ( P21)- When turning on the projector, it takes about 30 seconds to display an image.- Check the system that you select is corresponding with your computer or video equipment.- Select correct input source once again following the menu operation.- Make sure the temperature is not out of the operating temperature range 41 °F – 95 °F (5°C ~ 35°C).
No sound.	<ul style="list-style-type: none">- Check audio cable connection from audio input source. ( P15-16)- Adjust the audio source.- Press the VOLUME + button. ( P21)- Press the MUTE button. ( P21)

-
- Problem:** – Try These Solutions
-
- Remote Control does not work.**
- Check the battery.
 - Make sure nothing is between the infrared remote receiver and remote control.
 - Make sure you are not too far from the projector when using the remote control. Maximum operating range is 16.4' (5m).
 - Make sure the code of the remote control is set to conform to the projector. ( P38)
 - Unlock Key lock for the remote control in the Setting Menu. ( P38)

WARNING :

High voltages are used to operate this projector. Do not attempt to open the cabinet.

If the problem still persists after following all operating instructions, contact the sales dealer where you purchased the projector or the service center. Give the model number and explain the difficulty. We will advise you how to obtain service.

























 The CE Mark is a Directive conformity mark of the European Community (EC).

 **UL US LISTED**

This symbol on the nameplate means the product is Listed by Underwriters Laboratories Inc. It is designed and manufactured to meet rigid U.L. safety standards against risk of fire, casualty and electrical hazards.

Indicators and Projector Condition

Check the indicators for projector condition.

Indicators			Projector Condition
POWER red/green	WARNING red	LAMP REPLACE yellow	
			The projector is OFF. (The AC power cord is unplugged.)
			The projector is preparing for stand-by or the projection lamp is being cooled down. The projector cannot be turned on until cooling is completed.
			The projector is ready to be turned on with the POWER ON-OFF button.
			The projector is operating normally.
			The projector is in the Power management mode.
			The temperature inside the projector is abnormally high. The projector cannot be turned on. When the projector is cooled down enough and the temperature returns to normal, the POWER indicator lights red and the projector can be turned on. (The WARNING indicator keeps flashing.) Check and clean the air filters.
			The projector has been cooled down enough and the temperature returns to normal. When turning on the projector, the WARNING indicator stops flashing. Check and clean the air filters.
			The projector detects an abnormal condition and cannot be turned on. Unplug the AC power cord and plug it again to turn on the projector. If the projector is turned off again, disconnect the AC power cord and contact the dealer or the service center for service and checkup. Do not leave the projector on. It may cause an electric shock or a fire hazard.

 ●●● lights green.

 ●●● flashes green.

 ●●● lights red.

 ●●● flashes red.

 ●●● off

* When the life of the projection lamp draws to an end, the LAMP REPLACE indicator lights yellow. When this indicator lights yellow, replace the projection lamp with a new one promptly. Reset the Lamp replace counter after replacement of the lamp. (P42-43)

Menu Tree

Main menu

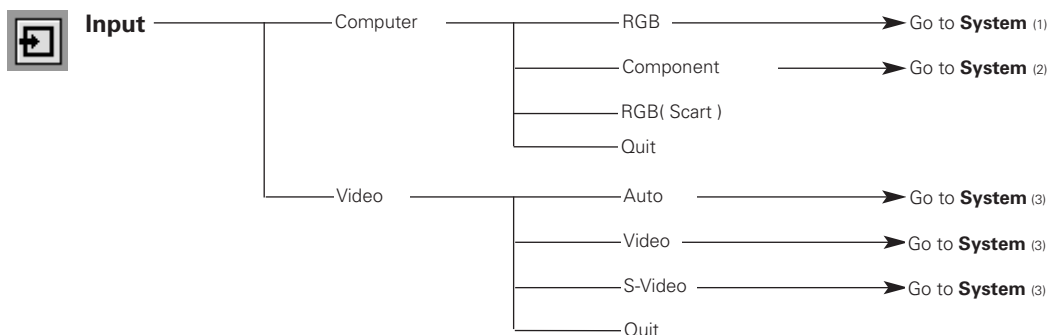

Computer Input

Main menu

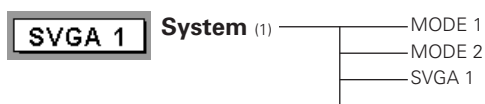

*Systems displayed in the system menu vary depending on the using environment.

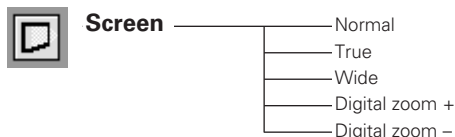
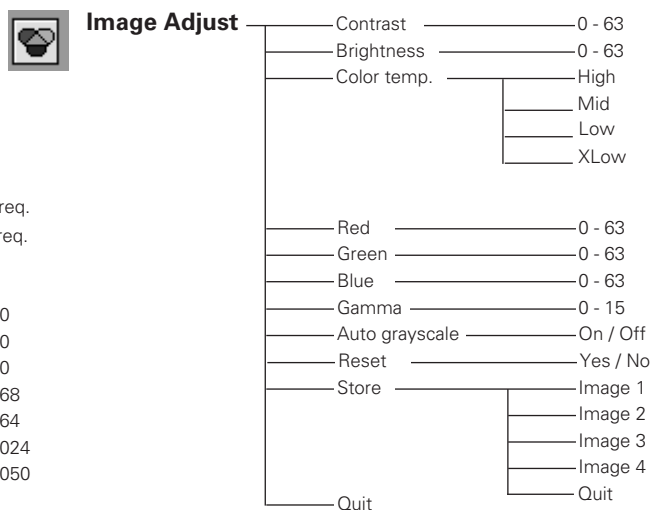
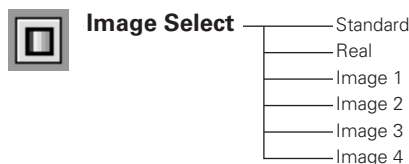
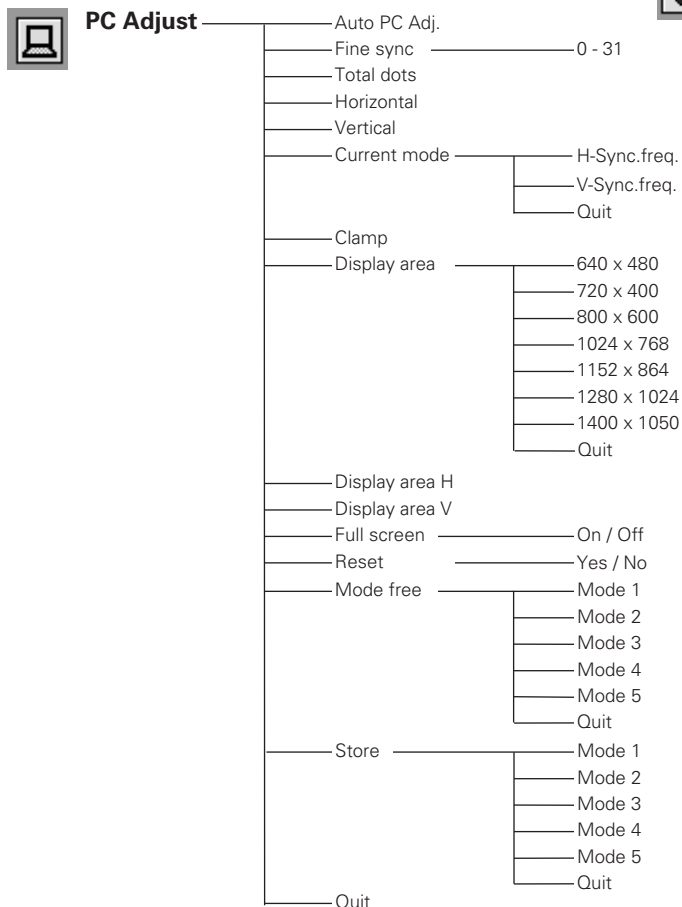

Video Input

Main menu

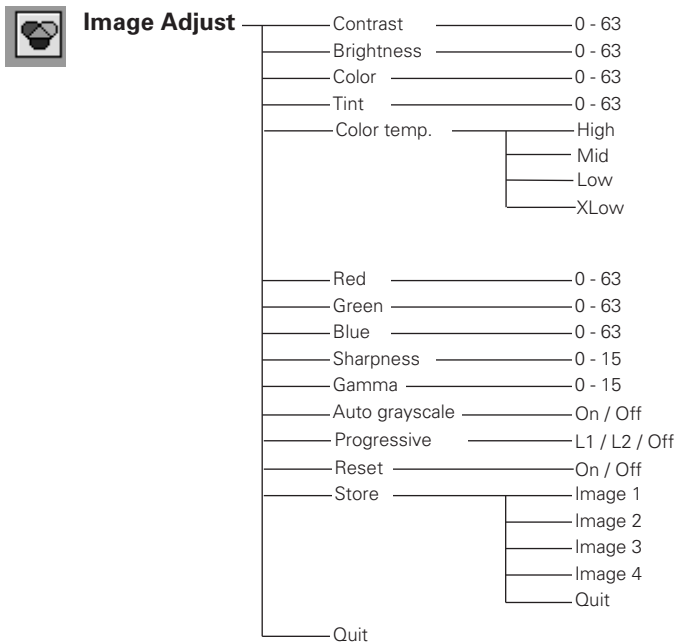
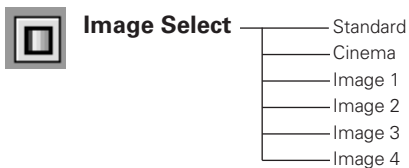
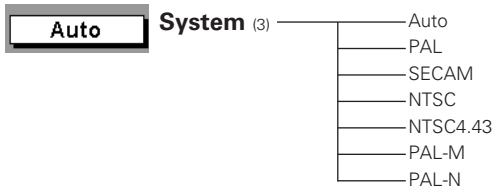
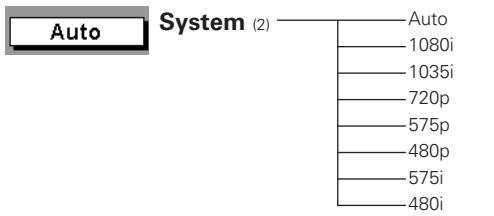

Settings

Main menu

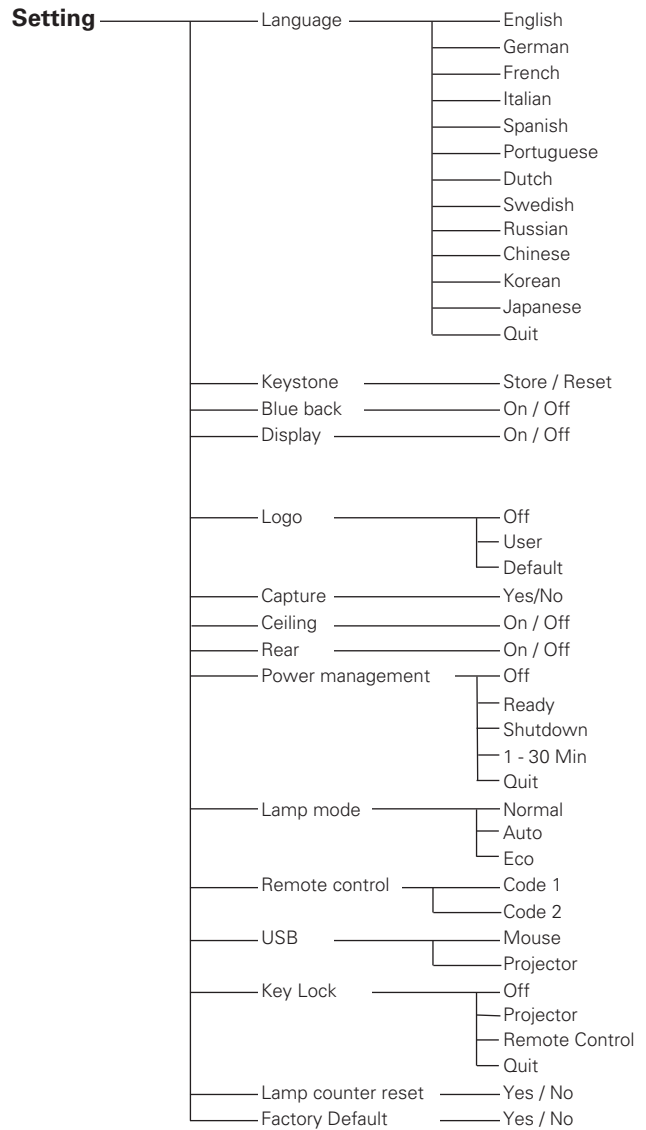
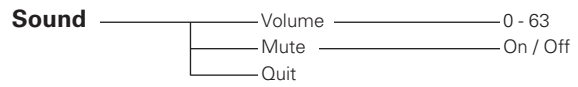

Compatible Computer Specifications

Basically this projector can accept the signal from all computers with the V, H-Frequency below mentioned and less than 100 MHz of Dot Clock.

ON-SCREEN DISPLAY	RESOLUTION	H-Freq. (kHz)	V-Freq. (Hz)	ON-SCREEN DISPLAY	RESOLUTION	H-Freq. (kHz)	V-Freq. (Hz)
VGA 1	640 x 480	31.47	59.88	XGA 2	1024 x 768	68.677	84.997
VGA 2	720 x 400	31.47	70.09	XGA 3	1024 x 768	60.023	75.03
VGA 3	640 x 400	31.47	70.09	XGA 4	1024 x 768	56.476	70.07
VGA 4	640 x 480	37.86	74.38	XGA 5	1024 x 768	60.31	74.92
VGA 5	640 x 480	37.86	72.81	XGA 6	1024 x 768	48.50	60.02
VGA 6	640 x 480	37.50	75.00	XGA 7	1024 x 768	44.00	54.58
VGA 7	640 x 480	43.269	85.00	XGA 8	1024 x 768	63.48	79.35
MAC LC13	640 x 480	34.97	66.60	XGA 9	1024 x 768	36.00	87.17 (Interlace)
MAC 13	640 x 480	35.00	66.67	XGA 10	1024 x 768	62.04	77.07
480p	————	31.47	59.88	XGA 11	1024 x 768	61.00	75.70
575p	————	31.25	50.00	XGA 12	1024 x 768	35.522	86.96 (Interlace)
480i	————	15.734	60 (Interlace)	XGA 13	1024 x 768	46.90	58.20
575i	————	15.625	50 (Interlace)	XGA 14	1024 x 768	47.00	58.30
SVGA 1	800 x 600	35.156	56.25	XGA 15	1024 x 768	58.03	72.00
SVGA 2	800 x 600	37.88	60.32	MAC 19	1024 x 768	60.24	75.08
SVGA 3	800 x 600	46.875	75.00	MAC 21	1152 x 870	68.68	75.06
SVGA 4	800 x 600	53.674	85.06	SXGA 1	1152 x 864	64.20	70.40
SVGA 5	800 x 600	48.08	72.19	SXGA 11	1152 x 900	61.20	65.20
SVGA 6	800 x 600	37.90	61.03	SXGA 13	1280 x 1024	50.00	86.00 (Interlace)
SVGA 7	800 x 600	34.50	55.38	SXGA 14	1280 x 1024	50.00	94.00 (Interlace)
SVGA 8	800 x 600	38.00	60.51	SXGA 17	1152 x 900	61.85	66.00
SVGA 9	800 x 600	38.60	60.31	SXGA 18	1280 x 1024	46.43	86.70 (Interlace)
SVGA 10	800 x 600	32.70	51.09	720p (HDTV)	————	45.00	60.00
SVGA 11	800 x 600	38.00	60.51	1035i (HDTV)	————	33.75	60.00 (Interlace)
MAC 16	832 x 624	49.72	74.55	1080i (HDTV)	————	33.75	60.00 (Interlace)
XGA 1	1024 x 768	48.36	60.00	1080i (HDTV)	————	28.125	50.00 (Interlace)

Note:

–Specifications are subject to change without notice.

Technical Specifications

Projector Type	Multi-media Projector
Dimensions (W x H x D)	10.63" x 3.07" x 7.48" (270mm x 78.0mm x 190mm) (not including Adjustable Feet)
Net Weight	4.6lbs (2.1 kg)
LCD Panel System	0.5" TFT Active Matrix type, 3 panels
Panel Resolution	800 x 600 dots
Number of Pixels	1,440,000 (800 x 600 x 3 panels)
Color System	PAL, SECAM, NTSC, NTSC4.43, PAL-M and PAL-N
High Definition TV Signal	480i, 480p, 575i, 575p, 720p, 1035i, and 1080i
Scanning Frequency	H-sync. 15 ~ 80 KHz, V-sync. 50 ~ 100 Hz
Projection Image size (Diagonal)	Adjustable from 34" to 200"
Projection Lens	F 1.6 ~ 1.8 lens with f 18.3 mm ~ 21.9 mm with manual zoom and focus
Throw Distance	4.3' ~ 21.2' (1.3 m ~ 6.5 m)
Projection Lamp	160 W
Video Input Jack	RCA Type x 1 (Video) and Mini DIN 4 pin x 1 (S-Video)
Audio Input Jack	Mini Jack (stereo) x 1
Computer Input Terminal	Analog RGB (Mini D-sub 15 pin) x 1
Computer Audio Input Jack	Mini Jack (stereo) x 1
Control Port Connector	Mini DIN 8 pin x 1
USB Connector	USB Series B receptacle x 1
Internal Audio Amp	0.8 W RMS
Built-in Speaker	1 speaker, ϕ 1.3" (32mm)
Feet Adjustment	0° to 8.0°
Voltage and Power Consumption	AC 100 ~ 120 V (2.4 A Max. Ampere), 50 / 60 Hz (The U.S.A and Canada) AC 200 ~ 240 V (1.2 A Max. Ampere), 50 / 60 Hz (Continental Europe)
Operating Temperature	41 °F – 95 °F (5 °C – 35 °C)
Storage Temperature	14 °F – 140 °F (-10 °C – 60 °C)
Remote Control	Power Source : AAA, SUM-04 or LR03 type x 2 Operating Range : 16.4' (5m) / \pm 30° Dimensions : 2.0"(W) x 0.91"(H) x 4.8"(D) (51.5mm x 23.2mm x 123mm) Net Weight : 2.11oz (60 g) (including battery)
Accessories	Owner's Manual AC Power Cord Remote Control and Battery VGA Cable Carrying Bag Lens Cover String for Lens Cover

- The specifications are subject to change without notice.
- LCD panels are manufactured to the highest possible standards. Even though 99.99% of the pixels are effective, a tiny fraction of the pixels (0.01% or less) may be ineffective by the characteristics of the LCD panels.

Configuration of Terminals

COMPUTER INPUT TERMINAL (ANALOG)

Terminal : Analog RGB (Mini D-sub 15-PIN)

Pin Configuration

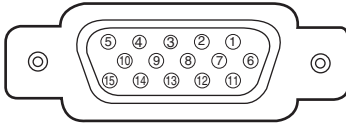

1	R / Cr, Pr Input	9	No Connect
2	G / Y Input	10	Ground (Vert.sync.)
3	B / Cb, Pb Input	11	Ground
4	No Connect	12	No Connect
5	Ground (Horiz.sync.)	13	Horiz. sync.
6	Ground (Red)	14	Vert. sync.
7	Ground (Green)	15	No Connect
8	Ground (Blue)		

SERVICE PORT CONNECTOR

Terminal : Mini DIN 8-PIN

Pin Configuration

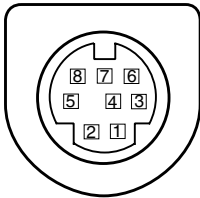

	PS/2	Serial	ADB
1	----	R X D	----
2	----	----	----
3	----	----	----
4	GND	GND	GND
5	----	----	----
6	----	T X D	----
7	----	----	----
8	----	----	----

USB CONNECTOR (Series B)

Pin Configuration

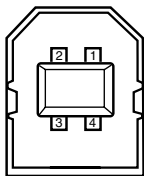

1	Vcc
2	- Data
3	+ Data
4	Ground

Optional Parts

The parts listed below are optionally supplied. When ordering those parts, give name and Type No. of it to the sales dealer.

- COMPONENT-VGA Cable

Type No. : POA-CA-COMPVGA

- SCART-VGA Cable

Type No. : AH-98881 (POA-CA-SCART)

EIKI

A-key to better communications

U.S.A.

EIKI International, Inc.
30251 Esperanza
Rancho Santa Margarita
CA 92688-2132
U.S.A.
Tel : 800-24-3454 (949)-457-0200
Fax : 800-457-3454 (949)-457-7878
E-Mail : usa@eiki.com

Deutschland & Österreich

EIKI Deutschland GmbH
Am Frauwald 12
65510 Idstein
Deutschland
Tel : 06126-9371-0
Fax : 06126-9371-14
E-Mail : info@eiki.de

Canada

EIKI CANADA - Eiki International, Inc.
P.O. Box 156, 310 First St. - Unit 2,
Midland, ON, L4R 4K8, Canada
Tel : 800-563-3454 (705)-527-4084
Fax : 800-567-4069 (705)-527-4087
E-Mail : canada@eiki.com

Eastern Europe

EIKI CZECH spol. s.r.o.
Umělecká 15
170 00 Praha 7
Czech Republic
Tel : +42 02 20570024
+42 02 20571413
Fax : +42 02 20571411
E-Mail : easterneurope@eiki.de

Japan & Worldwide

EIKI Industrial Company Limited.
4-12 Banzai-Cho, Kita-Ku, Osaka,
530-0028 Japan
Tel : +81-6-6311-9479
Fax : +81-6-6311-8486
E-Mail : japan@eiki.com

WorldWide Website <http://www.eiki.com>